

WWW.KLEINEWOLKE.COM



CLASSIC COLLECTION 2021

INHALT

CONTENT
CONTENU



2 WILLKOMMEN BEI KLEINE WOLKE

Welcome to Kleine Wolke
Bienvenue chez Kleine Wolke

4 DESIGNWELTEN

Worlds of design
Les mondes design

12 CREATIVO DESIGN

CREATIVO DESIGN
CREATIVO DESIGN

36 BADTEPPICHE / FROTTIER / HOLZMATTEN

Bath rugs / terry cloth / wooden mats
Tapis de bain / tissu-éponge / tapis en bois

118 ACCESSOIRES

Accessories
Accessoires

156 KOSMETIKEIMER / BAD ORGANISATION / HAKEN

Cosmetic bins / bathroom organisation / hooks
Poubelles à cosmétiques / organisation pour la salle de bain / crochets

178 KOSMETIKSPIEGEL

Cosmetic mirror
Miroir de maquillage

192 STATIC DECO ELEMENTS

Static cling film for bathroom decoration
Film électrostatique pour décorer les salles de bains

194 WC-SITZE

WC seats
Abattants WC

198 DUSCHVORHÄNGE

Shower curtains
Rideaux de douche

228 ZUBEHÖR + DUSCHROLLOS

Fittings / Shower blind
Garniture / Store de douche

238 SICHERHEITSEINLAGEN + DEKORE

Safety inserts / Deco-Accessories
Tapis anti-dérapants / Deco-Accessoires

254 EINSTIEGSPREISLAGEN

Entry price levels
Catégories de prix de départ

260 POS-VERMARKTUNGSKONZEPT

Marketing concepts
Concepts de commercialisations

271 SERVICE-VERTRIEB

Service sales
Service de distribution

273 REGISTER



WILLKOMMEN Welcome / Bienvenue



PORTRAIT

Mit innovativen und modischen Designs sind wir ein Synonym für hochwertige Badtextilien. Seit 1968 vertreiben wir unsere Produkte erfolgreich unter dem Markennamen Kleine Wolke und sind heute Marktführer im deutschsprachigen Raum.

Unser Produktspektrum umfasst Badteppiche, Frottierwaren, Accessoires, Duschvorhänge und Zubehör, Sicherheitseinlagen und Bettwäsche.

Mit rund 120 Mitarbeitern an unserem Hauptsitz in der Hansestadt Bremen und unserer Tochterfirma in Mägenwil (Schweiz) betreuen wir ca. 5.000 Kunden in 40 Ländern.

Unsere Handlungsweise ist von kundenorientierter Ausrichtung und unternehmerischem Denken geprägt. Langjährige Vertriebspartner sind der Fach- und Möbelhandel, Heimtextil-Fachmärkte, Warenhäuser, Baumärkte und Versandhäuser.

Seit 2010 sind wir Mitglied der international agierenden Unternehmensgruppe Possehl. 1847 gegründet, operiert Possehl heute in 9 Geschäftsbereichen, besteht aus 130 Gesellschaften und beschäftigt weltweit mehr als 8.500 Mitarbeiter. Hauptsitz der Unternehmensgruppe ist Lübeck.

With innovative and fashionable designs, we are a synonym for high-quality bathroom textiles. Since 1968, we have successfully distributed our products under the brand name Kleine Wolke. Today, we are a market leader in the German-speaking world. Our product range includes bath rugs, towels, shower curtains and accessories, bath safety inserts and bedding.

With around 120 employees at our head office in the Bremen, Germany, and our subsidiary company in Mägenwil, Switzerland, we serve around 5,000 customers in 40 countries. The way we do our business is characterised by a customer-oriented approach and entrepreneurial thinking. Our longstanding distribution partners include the specialist furniture trade, home textiles and specialist retailers, department stores, DIY stores and mail-order companies.

Since 2010, we have been a member of the internationally operating group of companies Possehl. Founded in 1847, Possehl today operates in nine different business areas, consists of 130 companies and employs over 8,500 employees around the world. The company group has its head office in Lübeck, Germany.

Avec nos designs innovants et tendance, notre nom est synonyme de linge de bain de qualité. Depuis 1968, nous distribuons nos produits avec succès sous la marque Kleine Wolke et sommes aujourd'hui leader du marché dans les pays germanophones. Notre gamme de produits comprend des tapis de bain, serviettes et accessoires de bain, rideaux et accessoires de douche, tapis antidérapants et parures de lit.

Nous comptons près de 120 employés à notre siège de Brême et dans notre filiale de Mägenwil (Suisse) et fournissons environ 5 000 clients dans 40 pays. Notre conduite est orientée client et imprégnée de l'esprit d'entreprise. Nos partenaires depuis de nombreuses années sont le mobilier professionnel et commercial, le textile d'ameublement, les grands magasins, les magasins de bricolage et les maisons de vente par correspondance. Depuis 2010 nous sommes membre du groupe d'entreprises international Possehl. Fondé en 1847, Possehl opère aujourd'hui dans neuf secteurs d'activité, est composé de 130 entreprises et emploie plus de 8 500 personnes dans le monde entier. Le siège du groupe d'entreprises est à Lübeck.

LIFESTYLE FÜR BAD & BETT

Lifestyle for the bedroom and bathroom

Le lifestyle pour le bain et pour le lit

Hochwertige Badprodukte in optimaler Qualität und aktueller Optik sorgen dafür, daß man sich Zuhause einfach himmlisch fühlt.

Unter dem Slogan „für Bad & Bett“ entwickelt unser Design-Team jährlich neue Dessinierungen und Produktinnovationen in topaktuellen Farbkombinationen und schafft unverwechselbare Wohnwelten – über Raumgrenzen hinaus.

Unsere Badteppiche, Frottierwaren und Bettwaren tragen das Zeichen für „Textiles Vertrauen. Schadstoffgeprüfte Textilien nach Öko-TEX Standard 100“. Damit haben unsere Kunden die Sicherheit, ein schadstofffreies und humanökologisch unbedenkliches Produkt zu kaufen. Durch strenge Vorgaben an unsere Lieferanten und ständige Qualitätskontrollen stellt Kleine Wolke sicher, dass die geforderten Normen in der Liefer- und Prozesskette eingehalten werden.



Our bathroom products of the highest quality and with the latest look make your home a heaven on earth.

With the slogan "for the bathroom and bedroom", every year our design team develops new patterns and product innovations in the most modern colour combinations to create distinctive living environments - beyond the boundaries of the room. Our bath mats, towels and bedding bear the OEKO-TEX Standard 100 quality mark for textiles tested for harmful substances. That is why our customers can rest assured that they are buying a human-ecologically sound product that is free from harmful substances. By issuing our suppliers with strict guidelines and implementing regular quality controls, Kleine Wolke ensures that all the applicable standards are adhered to in the supply and processing chains.

Nos produits de salle de bains de haute qualité au design actuel transforment votre foyer pour le rendre tout simplement divin.

Sous le slogan « pour le bain et pour le lit », notre équipe de designers développe toute l'année de nouveaux motifs et produits innovants dans des combinaisons de couleurs d'avant-garde et crée des ambiances uniques qui repoussent les limites de l'espace intérieur.

Nos tapis de bain, nos serviettes de bain et notre linge de lit portent le signe « Confiance textile. Textiles testés exempts de substances nocives selon la norme Öko-TEX Standard 100. » Nos clients sont ainsi certains d'acheter un produit exempt de substances nocives et inoffensif pour le corps humain et l'environnement. Grâce à des exigences strictes vis-à-vis de nos fournisseurs et des contrôles de qualité permanents, Kleine Wolke s'assure que les normes requises sont respectées au sein de la chaîne d'approvisionnement et de traitement.

Über unsere Produkte

About our products / À propos de nos produits

Badteppiche / Bath rugs / Tapis de bain

Die Qualität unserer Badteppiche ist geprägt von den eingesetzten, hochwertigen Florgarnen in Kombination mit ausgewählten Trägermaterialien und haltbaren Rückenbeschichtungen. In strengen Qualitätskontrollen testen wir laufend unsere Garne, Farbechtheiten und die Alterungsbeständigkeit der Beschichtungen, denn nur aus einwandfreien, hochwertigen Vormaterialien kann dann ein anspruchsvolles Produkt in aufwändiger Fertigung hergestellt werden.

The quality of our bath mats is distinguished by the use of premium gassed cotton yarns combined with a selection of base materials and durable back coatings. By implementing strict quality controls, we regularly test the yarns, the colourfastness and the ageing resistance of the coatings. Only with the use of flawless, high-quality primary materials can a sophisticated product can be manufactured as part of an elaborate production process.

La qualité de nos tapis de bain résulte des fibres de haute qualité utilisées en combinaison avec des supports sélectionnés et des sous-couches durables. Lors de contrôles qualité sévères, nous testons continuellement nos fibres, la résistance de la couleur et la résistance au vieillissement des revêtements, car seuls des matériaux sans défauts et de haute qualité permettent de fabriquer un produit exigeant à la finition élaborée.



Badorganisation / Bath organisation Organisation pour la salle de bain

Mit Kosmetikeimern, Wandhaken, Wäsche- und Aufbewahrungsboxen in vielen Varianten, Farben und Größen wird die Badorganisation perfekt.

Perfect bathroom organisation with cosmetic bins, wall hooks, laundry and storage boxes in a wide range of designs, colours and sizes.

Avec de nombreux modèles, couleurs et tailles de poubelles à cosmétiques, crochets muraux, paniers à linge et bacs de rangement, pour organiser idéalement votre espace de bains.



Accessoires / Accessories

Porzellan, Steinzeug oder Kunststoff? In Bezug auf Material oder Design lassen unsere Accessoires keine Wünsche offen. Die praktischen und optisch anspruchsvollen Produktserien sind ein Hingucker in jedem Badezimmer und bieten für jeden Stil die passende Lösung.

Porcelain, stoneware or plastic? When it comes to the material or design, our accessories satisfy your every wish. The practical and visually elegant product series are eye-catching features of any bathroom, offering you a suitable solution for every style.

Porcelaine, grès ou plastique? Que ce soit en termes de matériau ou de design, nos accessoires répondent à tous les désirs. Les lignes de produits pratiques et attrayantes attirent le regard dans chaque salle de bains et offrent la solution idéale quel que soit le style.

WC Sitze / WC seats / Abtants WC

Unsere modernen WC-Sitze verfügen über eine Absenkautomatik und passen für alle handelsüblichen WCs. Eine praktische Dübelbefestigung ermöglicht eine einfache Montage von oben. Mit dem Easy Click-System sind die Sitze zur Reinigung leicht abnehmbar. Alle Metallteile bestehen aus rostfreiem Edelstahl.



Our modern toilet seats have a soft closing mechanism and can be used on all commercial toilets. Practical plug fasteners make assembly from above easy. With the Easy Click system the seat can be easily removed for cleaning. All metal parts are made from rust-free stainless steel.

Nos sièges WC tendances disposent d'un mécanisme d'abaissement automatique et sont compatibles avec l'ensemble des WC usuels. La fixation pratique des chevilles permet de faciliter le montage par le haut. Grâce au système Easy Clic, les sièges peuvent être facilement retirés lors du nettoyage. Toutes les pièces en métal sont composées d'acier inoxydable.

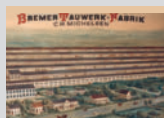

Unternehmensgründung durch den Kaufmann C.H. Michelsen – Herstellung von Tauen und Netzen

Founding of the company by businessman C.H. Michelsen – production of ropes and nets
Création de l'entreprise par le commerçant C.H. Michelsen – Production d'amarres et de filets

1793

Beginn der Fertigung von Webteppichen und Vorlegern aus Sisal und Wolle

Beginning of the production of woven carpets and rugs made of sisal and wool
Début de la production de tapis tissés et de tapis en sisal et en laine

1947

1968

Start der Produktion von Badteppichen unter dem Markennamen KLEINE WOLKE

Beginning of the production of bath mats under the brand name KLEINE WOLKE
Début de la production de tapis de bain sous la marque KLEINE WOLKE

Duschvorhänge / Shower curtains / Rideaux de douche

Grundsätzlich unterscheiden wir Duschvorhänge aus textilem Gewebe und aus Kunststoff-Folie. Dabei sind alle Produkte besonders haltbar und pflegeleicht. Unsere Textil-Duschvorhänge sind wasserabweisend, haben eine verstärkte Lochleiste mit stabilen Ösen und ein Gewichtsband im unteren Saum. Folien-Duschvorhänge liefern wir in kräftiger Vinyl-Folie oder aus PVC-freiem, umweltfreundlichem und recycelfähigem Material. Sie sind absolut wasserdicht.

We make a basic distinction between shower curtains made of woven textile material and those made of plastic film. All our shower curtains are made of a highly durable and easy-to-clean material. Our textile material shower curtains are water-resistant and have a reinforced strip of mounting holes with fixed rings and a weighted band in the lower seam. We supply film shower curtains made of strong vinyl film or PVC-free material that is both recyclable and environmentally friendly. They are completely watertight.

On distingue de manière générale deux types de rideaux de douche : en matière textile et en film plastique. Tous ces produits sont particulièrement résistants et faciles à entretenir. Nos rideaux de douche en matière textile sont imperméables et présentent une bande renforcée avec œillets robustes ainsi qu'une bande de lestage dans l'ourlet du bas. Nos rideaux de douche en film plastique sont disponibles en film de vinyle résistant ou en matériau sans PVC, écologique et recyclable. Ils offrent l'avantage d'une étanchéité absolue.



Sicherheitseinlagen / Safety inserts Tapis anti-dérapants

Unsere Einlagen für Dusche und Wanne bieten ein ausgewogenes Verhältnis zwischen Komfortanspruch und Sicherheitsaspekten. Für das Sortiment wird hochwertiger Qualitäts-PVC-Schaum oder PVC-freies Material (TPE) verwendet. Mit innovativer Fotodruck-Technologie können ausdrucksstarke Designs in brillanten Farben dargestellt werden.



Our bath and shower safety mats strike the perfect balance between comfort and safety. The product range uses high-premium phthalate-free quality PVC foam or PVC-free material (TPE). Thanks to our innovative photo printing technology, you can choose from a range of expressive designs in brilliant colours.

Nos tapis antidérapants pour douche et baignoire offrent un équilibre exceptionnel entre confort et sécurité. Pour cette gamme nous utilisons une mousse PVC sans phtalates de haute qualité ou encore un matériau sans PVC (TPE). Une technologie d'impression innovante permet l'obtention de motifs expressifs aux couleurs chatoyantes.

Bettwäsche / Bed linen / Parures de lit

Für unsere Bettwäsche werden ausgesuchte Rohstoffe verwendet. Unsere Garne und alle zusätzlichen Materialien und Accessoires wie Nähfäden oder Reißverschlüsse sind optimal auf das Produkt und seine lange Lebensdauer abgestimmt.

Selected primary materials are used for our bedding. Our yarns and all additional materials and accessories, including sewing threads and zip fasteners, are optimally adapted for the product and its long lifespan.

Pour nos parures de lit nous utilisons des matières premières sélectionnées. Nos fibres et tous les matériaux et accessoires supplémentaires tels que fils à coudre ou fermetures Éclair sont spécialement adaptés au produit et à sa longue durée de vie.

Sortimentserweiterung um Dusch- und Wanneneinlagen

Extension of the product range to include shower and bath safety mats

La gamme de produits accueille les tapis antidérapants pour douche et baignoire

1984

1999

Eingliederung des Unternehmens MEUSCH- Wohnen- Bad und Freizeit GmbH

Integration of the company MEUSCH- Wohnen- Bad und Freizeit GmbH
Intégration de la société MEUSCH- Wohnen- Bad und Freizeit GmbH

Aufnahme der Produktgruppe Bettwäsche ins Sortiment

Incorporation of bedding into the product range

Introduction des parures de lit dans la gamme de produits

2007

2010



Integration in die Possehl Unternehmensgruppe

Integration into the Possehl group of companies
Intégration au groupe d'entreprises Possehl



Logo-Relaunch

2016



DESIGNWELT

J'adore



J'ADORE – das bedeutet, lieben, verehren, umschwärmen...
 Warmes Aubergine, ein Unterton in Braun kombiniert mit violetten Bordeaux
 Tönen und Abstufungen ins Old Rose. Ein helles Beige schenkt den Hauch
 Leichtigkeit – so entsteht eine Farbkombi der Extraklasse.
 Zu diesem Thema arbeitet Kleine Wolke mit Unis, matten Oberflächen
 und fließenden, eleganten Mustern. Das Gesamtbild wirkt dadurch
 sehr edel und elegant mit einer großzügigen Opulenz.



J'ADORE means to love, worship, adore...
 Warm aubergine, an undertone of brown combined with violet Bordeaux
 tones and shades of old rose. A light beige adds a touch of lightness - creat-
 ing a colour composition in a league of its own.
 Kleine Wolke covers this theme with single colours, matt surfaces and flow-
 ing, elegant patterns. The overall look is therefore very noble and elegant with
 a generous opulence.

J'ADORE signifie aimer, chérir, admirer...
 L'aubergine chaude, une nuance de brun combinée à des tons violets de Bor-
 deaux et des nuances de rose ancien. Un beige clair ajoute une touche de
 légèreté, créant une composition de couleurs d'une élégance rare.
 Kleine Wolke travaille sur ce thème avec des couleurs unies, des surfaces
 mates et des motifs fluides et raffinés. L'aspect général est donc très noble et
 sophistiqué, témoignant également d'une grande richesse visuelle.



DESIGNWELT *Framework*



Eines der Lieblings-Themen für 2021: Schwarz Weiß. Neben den grafischen Elementen gehört auch Marmor weiterhin zu den absoluten Trendhighlights. Kleine Wolke hat zu diesem Thema den Badteppich Tira entwickelt. Die Duschvorhänge Bath und Reiselust setzen das klare und moderne Design weiter fort. Passend dazu: schwarzes DV Zubehör. Die neue Serie im Bereich Badorganisation „Framework“ sorgt für das i-Tüpfelchen und hat damit zurecht den Namen des Themas verdient.



One of the favourite themes for 2021: black and white. In addition to the graphic elements, marble continues to be one of the absolute trend highlights. Kleine Wolke created the Tira bathroom rug on this theme. The shower curtains Bath and Reiselust continue the clear and modern design. Matching: black DV accessories. The new bathroom organiser series Framework adds the finishing touch and quite rightly deserves its name.

Un des thèmes favoris pour 2021 : le noir et blanc. En plus de ses éléments graphiques, le marbre continue de figurer parmi les tendances phares. Kleine Wolke a développé le tapis de salle de bain Tira sur ce thème. Les rideaux de douche Bath et Reiselust empruntent également ce design clair et moderne. Assortiment avec : les accessoires DV noirs. Dédiée à l'organisation de la salle de bains, la nouvelle gamme « Framework » couronne notre assortiment de produits et porte donc fièrement ce nom anglophone.



DESIGNWELT *Magical Moments*



Wärmende Farben für die Seele – das ist Magical Moments. Mit diesem Thema erwachen die wunderbaren Erinnerungen an einen Sommerurlaub. Durch den größeren Fokus auf einen warmen Kupfertönen erstrahlt das Thema geradezu im neuen Sonnenlicht. Gebrannte Erdtöne und ein Multicolor aus Gelb, Grün und Blau unterstützen das Farbenspiel. Das Design „Magic“, ein buntes Design in Tropfenform, wird als bedruckter Badteppich sowie auf dem dazu passenden Duschvorhang umgesetzt.



Colours to warm the soul - that's Magical Moments. This theme awakens the wonderful memories of a summer holiday. The greater focus on a warm copper tone means that the theme virtually shines in new sunlight. Burnt earth tones and a multicolour of yellow, green and blue boost the play of colours. The Magic design, a colourful design in droplet shape, is presented as a printed bath rug as well as on a matching shower curtain.

Des couleurs chaudes pour l'âme, et vivre des moments de magie. Ce thème réveille les merveilleux souvenirs des vacances d'été. En mettant l'accent sur un ton chaud et cuivré, ce sujet brille pratiquement sous un nouveau jour. Des tons de terre brûlée et un mélange de jaune, de vert et de bleu accompagnent le jeu des couleurs. Le motif « Magic », design coloré en forme de goutte, est exposé sous forme de tapis de salle de bain imprimé et sur le rideau de douche assorti.





FÜR HÖCHSTE ANSPRÜCHE

FOR THE HIGHEST STANDARDS / POUR LES EXIGENCES LES PLUS ÉLEVÉES

Als Experten im Bereich Badteppiche bieten wir Ihnen mit dem Kleine Wolke Creativo Programm eine ganz besondere Kollektion. Ausgewählte Garne, hochwertigste Beschichtungen und handgefertigte Unikate von qualifiziertem Fachpersonal mit modernsten Techniken gefertigt – jeder Badteppich ist Handarbeit!

As experts when it comes to bathmats, we can offer you a very special collection with the Kleine Wolke Creativo Programme. Selected yarns, the highest quality coatings and unique pieces, handcrafted by qualified professionals using the most modern technologies – every bathmat is a piece of craftsmanship!

En tant qu'experts en tapis de bain, nous vous proposons avec le programme Kleine Wolke Creativo une collection bien particulière. Des fils sélectionnés, des revêtements de la plus haute qualité et des pièces uniques fabriquées manuellement par un personnel spécialisé et qualifié selon les toutes dernières techniques : chaque tapis de bain est confectionné à la main !



DIE CREATIVO-VORTEILE IM ÜBERBLICK

THE ADVANTAGES OF CREATIVO AT A GLANCE / APERÇU DES AVANTAGES CREATIVO

- Alle Produkte werden unter höchsten Qualitätsstandards gefertigt.
- Wir verarbeiten edelste Garne und können mit über 100 brillanten Farben jeden individuellen Geschmack treffen.
- Alle Creativo-Badteppiche sind mit einer hochwertigen, rutschhemmenden TPE-Beschichtung ausgestattet.
- Mit einer Lieferzeit von ca. 4-5 Wochen sorgen wir schnell für die Umsetzung Ihres Wunschteppichs.
- Alle Badteppiche sind bei 40° maschinenwaschbar und behalten so lange ihre einzigartige Optik und Haptik.
- Auf alle Produkte der Creativo Kollektion geben wir 5 Jahre Qualitätsgarantie.
- All products are manufactured to the highest standards of quality.
- We process the finest yarns, and with almost 100 brilliant colours, we have something to everyone's taste.
- All Creativo bathmats are equipped with an anti-slip and premium quality TPE-coating.
- With a delivery time of approx. 4 weeks, we ensure that your custom bathmat is quickly made into a reality.
- All bathmats are machine washable at 40° and maintain their unique look and feel for a very long time.
- We provide a 5 year quality guarantee for all products in the Creativo Collection.
- Tous les produits sont fabriqués selon les standards qualité les plus élevés.
- Nous traitons les fils les plus fins et grâce à plus de 100 couleurs éclatantes, nous pouvons répondre à tous les goûts individuels.
- Tous les tapis de bain Creativo sont équipés d'un revêtement en TPE antidérapant, de qualité supérieure.
- Avec un délai de livraison d'env. 4-5 semaines, nous vous garantissons de créer rapidement le tapis de vos rêves.
- Tous les tapis de bain sont lavables en machine à 40°, ce qui leur permet de conserver durablement leur optique et leur sensation au toucher.
- Tous les produits de la collection Creativo sont couverts par une garantie qualité de 5 ans.



MODELLÜBERSICHT / PRODUCT CHOICE / CHOIX DE PRODUIT

RELAX	18-19	COLLINA NEW	27	MEANDRO	32
GRANDEZZA	22-23	CORSO	28	MELODIA	33
ANGELO	24	EMOZIONE	29	MITILO	34
CASSETTA	25	HARMONIA	30	VALLETTA NEW	35
CENTRO NEW	26	INTERNO	31		



DAS CREATIVO DESIGN-PROGRAMM - SO INDIVIDUELL WIE DAS EIGENE BAD!

THE CREATIVO DESIGN PROGRAMME - AS INDIVIDUAL AS YOUR OWN BATHROOM!
LE PROGRAMME CREATIVO DESIGN - AUSSI PERSONNALISÉ QUE VOTRE SALLE DE BAINS !

by Kleine Wolke

CREATED + DESIGNED BY KLEINE WOLKE

Hier finden Sie hochwertigste Badteppiche in besonders anspruchsvollen und außergewöhnlichen Designs. Unser Designteam hat harmonische Farbkombinationen in vielen beliebten Größen für Sie entwickelt.

Here you will find high-quality bathmats in particularly sophisticated and unusual designs.

Our design teams have developed coordinated colour combinations for you in various popular sizes.

Ici, vous trouverez des tapis de bain de la plus haute qualité, dans des designs particulièrement soignés et originaux. Notre équipe design a conçu pour vous des combinaisons de couleur harmonieuses, disponibles dans les tailles les plus courantes.

CREATED BY KLEINE WOLKE – DESIGNED BY YOU

Sie finden ein Design aus der Creativo Kollektion attraktiv, wünschen aber eine andere Größe oder Farbzusammenstellung? Kein Problem. Passen Sie die vom Kleine Wolke-Designteam entwickelten Modelle an Ihre individuellen Bedürfnisse an und entwerfen Sie eigene Farb- und Größenkombinationen.

Have you spotted an attractive design from the Creativo Collection, but you'd like it in a different size or colour combination? No problem. Adapt the models developed by the Kleine Wolke Design Team to your individual requirements and create your own colour and size combinations.

Un design de la collection Creativo vous plaît, mais vous souhaitez le commander sous une autre taille ou combinaison de couleurs ? Aucun problème. Adaptez à vos besoins individuels les modèles développés par l'équipe design Kleine Wolke, et créez vos propres combinaisons de couleurs et de taille.

CREATED + DESIGNED BY YOU

Ihr Badteppich braucht 6 Ecken? Für uns kein Problem, wir fertigen individuellste Grundformen und können selbst Ihre eigenen Designentwürfe umsetzen. Fordern Sie uns heraus und schicken uns Ihre maßstabsgerechte Schablone oder Ihren ganz persönlichen Entwurf.

Does your bathmat require 6 edges? That's not an issue for us, as we make the most highly customised of basic shapes and we can even implement your own designs. Give us a challenge by sending us your scale template or your own entirely personal design.

Vous souhaitez tapis de bain à 6 côtés ? Aucun problème, car nous fabriquons les formes de tapis les plus individuelles, et pouvons même répondre à vos projets design. Mettez-nous au défi, et envoyez-nous votre patron à l'échelle ou votre projet personnel.

IN NUR WENIGEN SCHRITTEN ZUM INDIVIDUELLEN WUNSCHTEPPICH

YOUR CHOSEN CUSTOMISED BATHMAT IN JUST A FEW STEPS
LE TAPIS DE BAIN IDÉAL EN QUELQUES ÉTAPES SEULEMENT

1_ Wählen Sie zunächst Ihr Lieblingsmodell aus der CREATIVO DESIGN KOLLEKTION aus.

First choose your favourite model from the CREATIVO DESIGN COLLECTION.

Choisissez tout d'abord votre modèle préféré, issu de la COLLECTION CREATIVO DESIGN.

2_ Wählen Sie eine von vielen beliebten Größen und Formen für Ihren Wunschteppich aus. Oder bestimmen Sie Ihr eigenes Maß nach Ihren Bedürfnissen. Sondermaße sind erhältlich von 50 x 50 cm bis zu 150 x 300 cm.

Select one of the many popular sizes and shapes for your custom bathmat. Or specify your own dimensions according to your requirements. Special dimensions are available from 50 x 50 cm up to 150 x 300 cm.

Faites votre choix parmi les tailles et formes populaires, pour trouver le tapis de bain de vos rêves. Ou déterminez vos propres dimensions de tapis, selon vos besoins. Les dimensions spéciales sont disponibles de 50 x 50 cm à 150 x 300 cm.

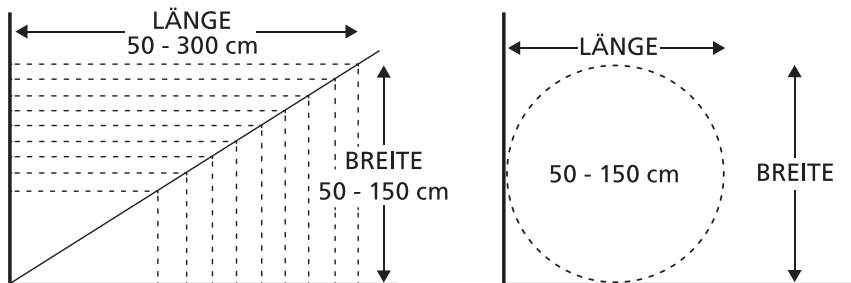

Bei den Uni-Modellen RELAX und GRANDEZZA sind auch weitere Sondergrößen in den Maßen 20 x 20 cm bis zu 150 x 350 cm möglich.

For the models RELAX and GRANDEZZA other additional individual sizes, varying from 20 x 20 cm until 150 x 350 cm are possible.

Pour les modèles unis RELAX et GRANDEZZA, d'autres tailles spéciales sont disponibles aux dimensions 20 x 20 cm jusqu'à 150 x 350 cm.

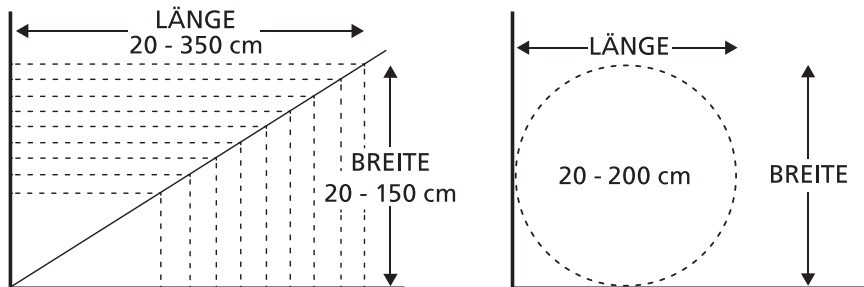

3_ Entscheiden Sie sich für eine Wunschfarbe bzw. Wunschkombination aus über 100 verfügbaren Farben.

Decide on your desired colour or colour combinations from a choice of over 100 available colours.

Optez pour la couleur ou l'association de couleurs de votre choix dans une palette avec plus de 100 coloris.

4_ Beim Modell GRANDEZZA können Sie zudem Ihre Wunschflorhöhe festlegen. Erhältlich ist dieses Modell in 15, 20, 25 und 30 mm.

For the GRANDEZZA model, you can also specify your preferred pile height. This model is available in 15, 20, 25 and 30 mm.

Pour le modèle GRANDEZZA, vous pouvez également déterminer la hauteur des fibres. Ce modèle est disponible en 15, 20, 25 et 30 mm.

MIT DER SCHABLONENFERTIGUNG WERDEN SIE ZUM EIGENEN DESIGNER - CREATED + DESIGNED BY YOU

BECOME YOUR OWN DESIGNER WITH TEMPLATE PRODUCTION
DEVENEZ DESIGNER EN FABRIQUANT VOS PATRONS

Besonders individuell. Einzigartig in Design oder Form. Ihr Wunschteppich wird zum Unikat!

Particularly individual. Unique in design or shape. Your custom bathmat will be one of a kind!

Très personnel. Un design ou une forme originale. Votre tapis est une pièce unique.



Sie möchten ein tolles Motiv aus Ihrem Bad aufgreifen, z.B. das Design des Duschvorhanges?

Would you like to take inspiration from an attractive theme in your own bathroom, e.g. the design on the shower curtain?

Vous souhaitez reproduire un joli motif issu de votre salle de bain, par exemple le design de votre rideau de douche ?

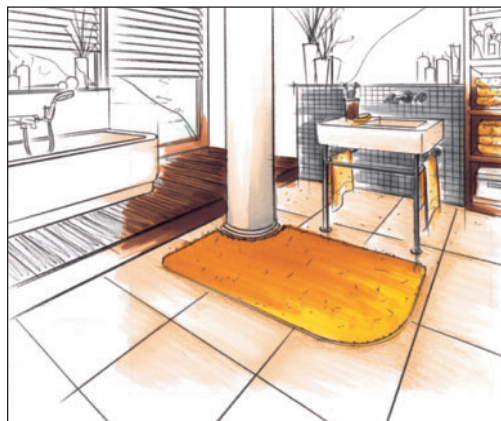

Ihr Wunschteppich braucht ganz spezielle Maße oder eine Säule steht im Weg?

Does your desired bathmat require specialised dimensions, or is there a pillar in the way?

Le tapis de votre choix nécessite des dimensions bien spécifiques, ou une colonne se tient au milieu de votre pièce ?



Sie möchten in Ihrem Bad etwas ganz eigenes und würden gerne wie „auf Wolken gehen“?

Do you want to add something completely your own to your bathroom and would you like to "walk on clouds"?

Vous souhaitez faire de votre salle de bien un espace unique, qui vous permettra de garder la tête dans les nuages ?

- Schicken Sie uns Ihre maßstabsgerechte Schablone.
- Zeichnen Sie ggf. Ihr Design auf die Schablone und bezeichnen die Farbfelder mit den Farbnummern unserer Farbpalette (Seiten 20-21).
- Lieferzeit bei Schablonenanfertigungen ca. 6 Wochen.
- Nur Florhöhe 25 mm möglich.

Art.-Nr.: **7446** / Preis auf Anfrage!

- Send us your scale template.
- If desired, sketch your design onto the template and indicate the areas of colour using the colour numbers on our colour palette. (Pages 20-21).
- Regular delivery time for the stencil production is about 6 weeks.
- Pile height of only 25 mm possible.

Art.-Nr.: **7446** / Price upon request!

- Envoyez-vous votre patron à l'échelle.
- Si nécessaire, dessinez votre design sur un patron, et déterminez les champs de couleur en utilisant les numéros de couleur sur notre palette de coloris (pages 20-21).
- Délai de livraison d'env. 6 semaines pour la fabrication des patrons.
- Hauteur de poils de seulement 25 mm possible.

Art.-Nr.: **7446** / Prix sur demande !



created + designed by you



BERECHNUNGSBEISPIELE FÜR WUNSCHMASS

CALCULATION EXAMPLES FOR CUSTOM DIMENSIONS

EXEMPLES DE FACTURATION POUR LES DIMENSIONS DE VOTRE CHOIX

Haben Sie ein individuelles Maß für Ihr Modell gewählt, errechnet sich unsere unverbindliche Preisempfehlung (UVP) über den Quadratmeterpreis:

If you have chosen customised dimensions for your model, our non-binding price recommendation (RRP) is calculated using the price per square metre:

Si vous avez sélectionné une taille personnalisée pour votre modèle, notre prix de vente conseillé (PVC) se calcule en fonction du prix au mètre carré :

- ➔ **GRANDEZZA** **1 qm = 199,99 €**
- ➔ **RELAX** **1 qm = 199,99 €**
- ➔ **alle anderen CREATIVO MODELLE** **1 qm = 299,99 €**

Beispiele / Examples / Exemples:

GRANDEZZA

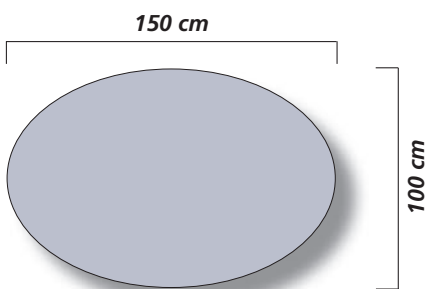

100 cm (Breite) x 150 cm (Länge), oval

100 cm (width) x 150 cm (length), oval

100 cm (largeur) x 150 cm (longueur), ovale

Breite x Länge = zu berechnende Fläche: 100 cm x 150 cm = 1,5 qm
€ 199,99 x 1,5 qm = 299,99 €

Width x Length = Area to be calculated: 100 cm x 150 cm = 1.5 m²

€ 199,99 x 1,5 qm = 299,99 €

Largeur x longueur = superficie à calculer: 100 cm x 150 cm = 1,5 m²

€ 199,99 x 1,5 qm = 299,99 €

RELAX

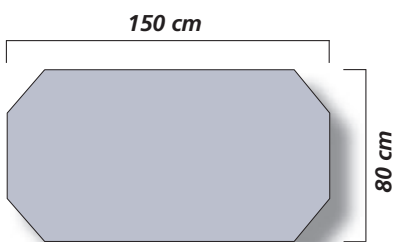

80 cm (Breite) x 150 cm (Länge), achteckig

80 cm (width) x 150 cm (length), octagonal

80 cm (largeur) x 150 cm (longueur), octogonal

Breite x Länge = zu berechnende Fläche: 80 cm x 150 cm = 1,2 qm
€ 199,99 x 1,2 qm = 239,99 €

Width x Length = Area to be calculated: 80 cm x 150 cm = 1,2 m²

€ 199,99 x 1,2 qm = 239,99 €

Largeur x longueur = superficie à calculer: 80 cm x 150 cm = 1,2 m²

€ 199,99 x 1,2 qm = 239,99 €

ANGELO

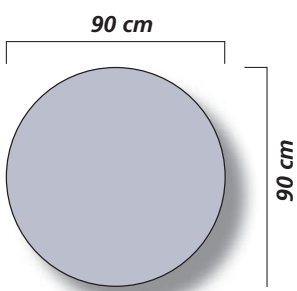

90 cm (Durchmesser), rund

90 cm (diameter), round

90 cm (diamètre), rond

Breite x Länge = zu berechnende Fläche: 90 cm x 90 cm = 0,81 qm
€ 299,99 x 0,81 qm = 242,99 €

Width x Length = Area to be calculated: 90 cm x 90 cm = 0.81 m²

€ 299,99 x 0,81 qm = 242,99 €

Largeur x longueur = superficie à calculer: 90 cm x 90 cm = 0,81 m²

€ 299,99 x 0,81 qm = 242,99 €

BESTELLMILFEN

ORDER HELP
AIDE POUR VOTRE COMMANDE

BESTELLMFORMULAR

ORDER FORM
FORMULAIRE DE COMMANDE

Auswahl von Form und Größe
Select shape and size
Sélection de la forme et des dimensions

Auswahl von Wunschgrößen
Select custom sizes
Sélection des dimensions souhaitées

Auswahl aus beliebigen Farben oder Wunschfarben
Select from popular colours or custom colours
Sélection parmi les couleurs populaires, ou coloris de votre choix

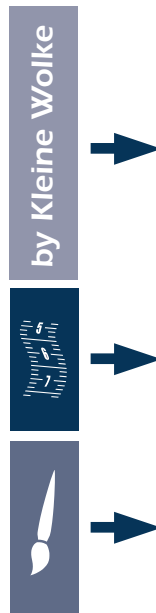

WEB-KONFIGURATOR

www.creativo.kleinewolke.com

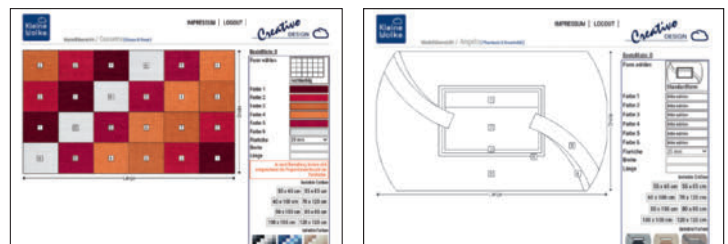

Bei vielen Kleine Wolke-Fachhändlern haben Sie die Möglichkeit Ihrer Kreativität freien Lauf zu lassen. Mit unserem web-basierten Creativo-Konfigurator gestalten Sie Schritt für Schritt Ihren individuellen Wunschteppich. Ob Farbe, Form, Größe oder Florhöhe – Ihr Kleine Wolke-Fachhändler unterstützt Sie bei Fragen und kümmert sich anschließend um die Bestellung.

Among many Kleine Wolke specialist dealers you may give your creativity free rein. Our web-based Creativo configurator enables you to personalize your individual bathmat. No matter if it is colour, design, size or pile height, your Kleine Wolke dealer will continue to help you on every question you may have and subsequently take care of your order.

Laissez libre cours à votre créativité chez de nombreux revendeurs Kleine Wolke. Avec notre configurateur en ligne Creativo, créez le tapis de votre choix étape par étape. Votre revendeur Kleine Wolke vous accompagne pour toute question autour de la couleur, forme ou hauteur de fibres de votre produit, et s'occupe ensuite de votre commande.

Verkaufs- und Lieferbedingungen Creativo Design

Sales and Delivery Terms and Conditions Creativo Design / Conditions de vente et de livraison Creativo design

Alle Maßangaben verstehen sich unter Berücksichtigung der handelsüblichen Toleranzen von +/-5%. Für alle Creativo Design Sonderanfertigungen besteht grundsätzlich eine Abnahmeverpflichtung. **Technische Änderungen und handelsübliche Farbabweichungen müssen wir uns vorbehalten.** Lieferzeiten innerhalb von ca. 4-5 Wochen. Für Wunschfarben und Wunschflorhöhen (nur bei Grandezza möglich) erheben wir keinen Aufpreis. Bei Bestellungen ohne Angabe der Wunschflorhöhe (Grandezza) wird die von unserem Haus empfohlene Florhöhe gefertigt.

All measurement information stated shall allow for the standard tolerances of +/-5%. For all custom-made products from Creativo Design there is a fundamental acceptance obligation. **We must reserve the right to make technical modifications and customary deviations in colour.** Delivery times within approx. 4-5 weeks. There is no surcharge for selecting custom colours and pile heights (only available for Grandezza). For orders that do not specify a custom pile height (Grandezza), the product will come with the pile height recommended by our experts.

Conditions de vente et de livraison Creativo design L'ensemble des dimensions se comprennent en tenant compte d'un écart habituel de +/-5%. Pour toutes les fabrications spéciales de Creativo Design, il existe une obligation d'achat. **Sous réserve de modifications techniques et différences de couleur usuelles.** Délai de livraison dans les 4-5 semaines ouvrées. Aucun supplément n'est requis pour les couleurs et les hauteurs de fibres souhaitées (uniquement possible pour Grandezza). Lors de commandes passées sans indiquer la hauteur de fibres souhaitée (Grandezza), nous vous livrons la hauteur de fibres conseillée par notre marque.

RELAX



Folgende Farben stehen Ihnen für unser Modell RELAX zur Verfügung.

The following colour blends are available for our RELAX model.

Les couleurs chinées suivantes sont disponibles pour notre modèle RELAX.



* 115 Polarweiß



189 Grau



220 Champagner



264 Walnuss



271 Taupe



291 Bast



311 Mahagoni



316 Rost



332 Rosenholz



413 Pastellrose



453 Rubin



461 Purple



569 Goldgelb



615 Kiwigrün



663 Pazifik



672 Türkis



723 Azur



736 Atlantikblau



858 Crocus



901 Anthrazit



* 926 Schwarz

* Nicht meliert / Not flecked / Non chiné

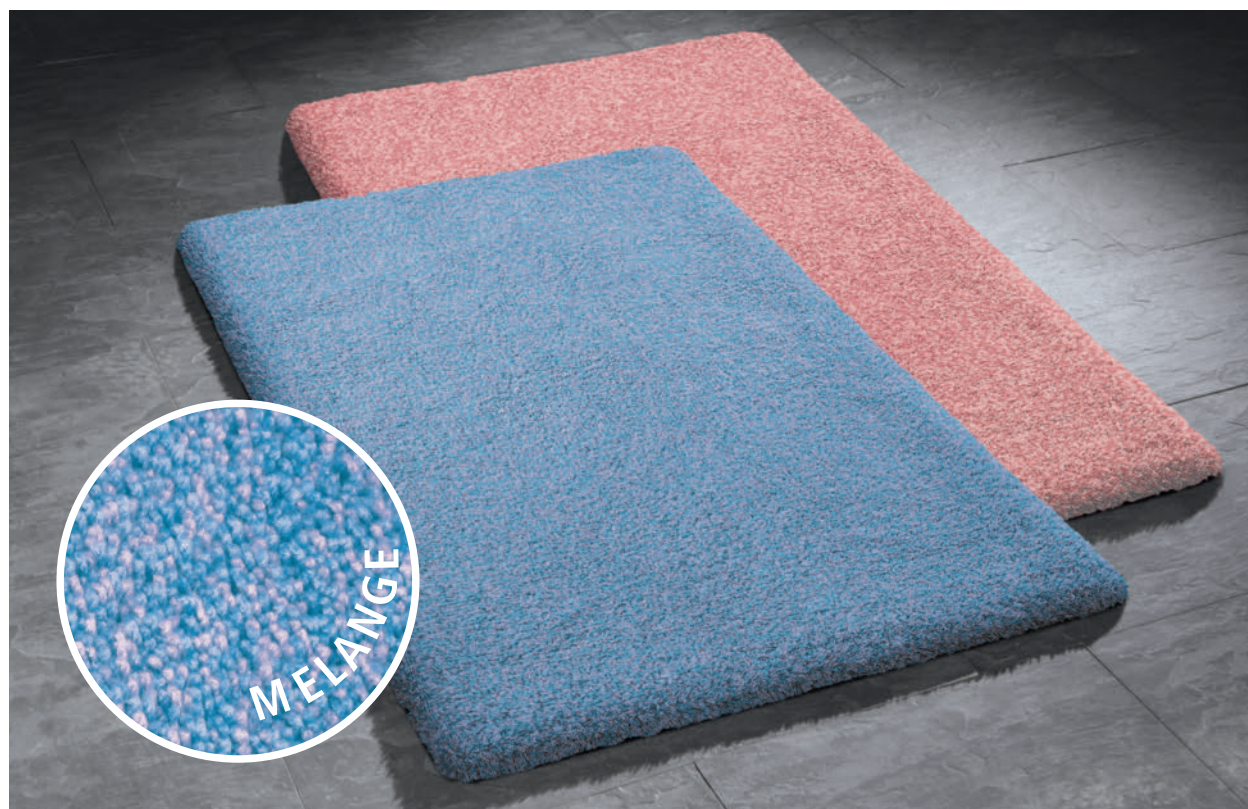

WUNDERSCHÖN UND ZEITLOS ELEGANT.

BEAUTIFUL AND TIMELESSLY ELEGANT. MAGNIFIQUE, ÉLÉGANT ET INTEMPOREL.

Das Modell RELAX überzeugt im besonderen durch die außergewöhnliche Melange-Optik. 21 mögliche Farben* stehen zur Verfügung. Sehr edel und mit **30 mm** Florhöhe sehr hochwertig, verschönert dieses Modell jedes Bad.

The RELAX model is particularly appreciated by customers thanks to its unusual blended look. 21 possible colour blends* are available to choose from.

Very sophisticated and – with a **30 mm** pile height – very high-quality, this model improves the look of any bathroom.

Le modèle RELAX se distingue grâce à son apparence chinée si exceptionnelle. 21 couleurs chinées* sont disponibles.

Très élégant, et d'une qualité supérieure grâce à sa hauteur de fibres de **30 mm**, ce modèle saura mettre chaque salle de bain en valeur.

* 100 Weiß + 926 Schwarz sind nicht meliert * 100 Weiß + 926 Schwarz: not flecked * 100 Weiß + 926 Schwarz: non chiné



Ihr gewohntes RELAX-Sortiment sowie Deckelbezug finden Sie auf den Seiten 38-39.

You can find the standard RELAX product range as well as toilet lid covers on pages 38/39.

Retrouvez l'assortiment RELAX habituel, ainsi que les housses d'abattant aux pages 38 / 39.

BELIEBTE GRÖSSEN UND FORMEN

POPULAR SIZES AND SHAPES
TAILLES ET FORMES POPULAIRES

Beliebte Größen (cm) Popular sizes (cm) Tailles populaires (cm)	Größenschlüssel Size key Classement des tailles		7431 ... Viereck Square Carré spitze Ecken pointed corners coins pointus 	7432 ... Achteck Octagonal Octogonal 	7433 ... Oval Oval Ovale 
55 x 55 m.A.	129		●	●	●
55 x 65	539		●	●	●
55 x 85	270		●	●	●
60 x 100	360		●	●	●
70 x 120	311		●	●	●
80 x 150	317		●	●	●
80 x 80	290		●	●	
100 x 100	720		●	●	
120 x 120	728		●	●	

by Kleine Wolke



WUNSCHMASS CUSTOM DIMENSIONS DIMENSIONS SOUHAITÉES

Wählen Sie Ihr individuelles Wunschmaß von 50 x 50 cm bis zu 150 x 300 cm oder rund 50 - 200 cm.

Choose your customised dimensions from 50 x 50 cm up to 150 x 300 cm or 50 - 200 cm (round).

Sélectionnez vos dimensions personnalisées de 50 x 50 cm à 150 x 300 cm ou au format rond, de 50 à 200 cm.

qm (000)

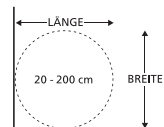
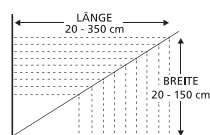

WUNSCHFARBEN CUSTOM COLOURS COULEURS SOUHAITÉES

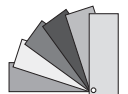

Wählen Sie aus den 21 Farben der RELAX-Farbpalette.

Choose from the 21 colours in the RELAX colour palette. Faites votre sélection parmi les 21 couleurs de la palette RELAX.

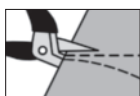

SCHABLONENFERTIGUNG TEMPLATE PRODUCTION FABRICATION D'UN PATRON

Sie benötigen eine außergewöhnliche Form? Gestalten Sie doch einfach Ihren persönlichen Badteppich ganz nach Ihren Bedürfnissen.

Do you require an unusual shape? You can still design your own customised bathmat entirely in line with your requirements.

Vous avez besoin d'une forme originale ? Créez tout simplement votre tapis de bain personnel, selon vos besoins.

7460 ... 999

Für Schablonenfertigung RELAX bitte ausschließlich die Artikel-Nummer 7460 benutzen.

For RELAX template production, please only use the item number 7460.

Pour fabriquer un patron RELAX, veuillez utiliser le numéro d'article 7460.



100% Polyacryl

FARBÜBERSICHT

COLOUR OVERVIEW
APERÇU DES COULEURS

Über 100 Farben stehen Ihnen für die Gestaltung unserer CREATIVO DESIGN KOLLEKTION zur Verfügung.

Over 100 colours are available for use in the design of our CREATIVO DESIGN COLLECTION.

Plus de 100 couleurs vous sont proposées pour la création de notre COLLECTION CREATIVO DESIGN.

100 Weiß	553 Mimose	443 Magnolie	607 Salbeigrün
220 Champagner	573 Canari	442 Flamingo	672 Türkis
203 Korn	569 Goldgelb	472 Malve	675 Petrol
217 Berberbeige	568 Sunshine	401 Nelke	766 Türkis
226 Sandbeige	539 Safran	413 Pastellrose	663 Pazifik
291 Bast	370 Sandelholz	457 Hellrosa	738 Hellblau
266 Ingwer	319 Aprikose	407 Old Rose	723 Azur
264 Walnuss	322 Pfirsich	431 Rouge	720 Blau
289 Seide	316 Rost	436 Beere	769 Marineblau
272 Macadamia	331 Karotte	415 Koralle	712 Sorr.-Azurblau
271 Taupe	333 Brandy	437 Geranie	736 Atlantikblau
287 Kaschmir	334 Chili	428 Bordeaux	789 Dunkelblau
224 Toffee	398 Pearl	451 Weinrot	791 Himmelblau
231 Bambusbeige	397 Papaya	438 Melone	798 Königsblau
342 Brasil	396 Lachs	453 Rubin	799 Royalblau
311 Mahagoni		468 Granat	746 Stahlblau
301 Nussbraun		460 Cyclam	754 Iceblue
		461 Purple	783 Mare
			812 Holunder
			892 Pflaume
			872 Aubergine

FARBÜBERSICHT

COLOUR OVERVIEW
APERÇU DES COULEURS

689 Zeder
605 Alge
603 Palme
602 Klee
601 Mooshellgrün
635 Farn
619 Linde
617 Distel
630 Pistazie
633 Minze
657 Tanne
625 Maigrün
615 Kiwigrün

115 Polarweiß
158 Auster
151 Kiesel
146 Silbergrau
179 Flanell
189 Grau
913 Nebel
977 Platin
901 Anthrazit
905 Schiefer
926 Schwarz

304 Terracotta
325 Siena
327 Marsala
332 Rosenholz
685 Maledivia
698 Eucalyptus

Farbmusterstreifen

Farbmusterstreifen mit den Creativo-Design Polyacryl-Farben

Colour sample strips showing the Creativo Design polyacrylic colours.

Échantillons disponibles dans les couleurs de polyacrylique Creativo Design.

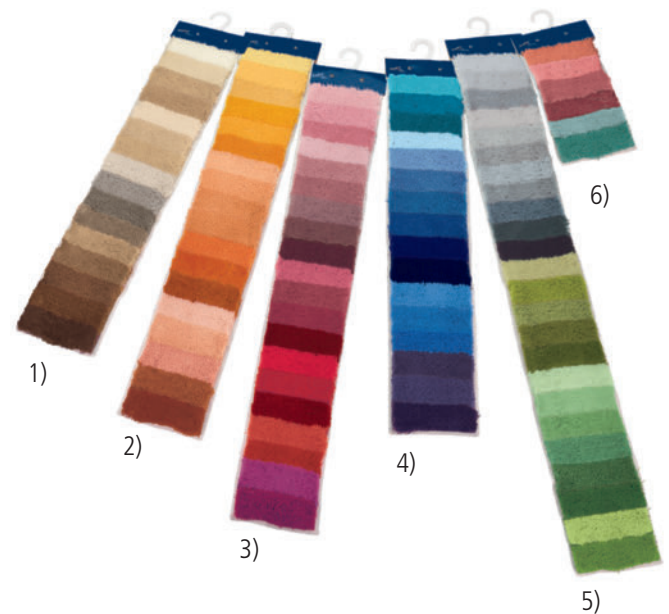

- 1) 0004 070 000
- 2) 0004 071 000
- 3) 0004 072 000
- 4) 0004 073 000
- 5) 0004 074 000
- 6) 0004 095 000

GRANDEZZA



WUNDERSCHÖN UND ZEITLOS ELEGANT.

BEAUTIFUL AND TIMELESSLY ELEGANT. MAGNIFIQUE, ÉLÉGANT ET INTEMPOREL.

Mit dem Uni-Modell GRANDEZZA aus der CREATIVO DESIGN KOLLEKTION erwerben Sie ein besonders hochwertiges Produkt.

Dieses Modell ist in **15 mm, 20 mm, 25 mm** oder **30 mm** ohne Preisunterschied erhältlich.

Wir empfehlen eine Florhöhe von 25 mm für optimale Haptik und perfekten Stand des Polyacryl-Garns.

With the unique GRANDEZZA model from the CREATIVO DESIGN COLLECTION you are purchasing a particularly high-quality product.

This model is available in **15 mm, 20 mm, 25 mm** or **30 mm** without a difference in price.

We recommend a pile height of 25 mm for the ideal feel and the perfect condition of the polyacrylic fibres.

Grâce au modèle unicolore GRANDEZZA issu de la COLLECTION CREATIVO DESIGN, vous faites l'acquisition d'un produit exceptionnel, de qualité supérieure. Ce modèle est disponible en **15 mm, 20 mm, 25 mm 30 mm**, sans différence de prix. Nous recommandons une hauteur de fibres de 25 mm, pour une sensation optimale au toucher et un maintien idéal du fil en polyacrylique.

15

20





25

30

BELIEBTE GRÖSSEN UND FORMEN

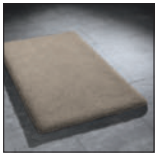
POPULAR SIZES AND SHAPES

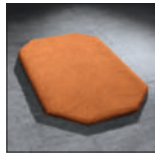
TAILLES ET FORMES POPULAIRES

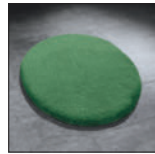
Beliebte Größen (cm) Popular sizes (cm) Tailles populaires (cm)	Größen-schlüssel Size key Classement des tailles	8709 ... Viereck Square Carré	8711 ... Viereck Square Carré	8710 ... Achteck Octagonal Octogonal	8712 ... Oval Oval Ovale	7435 ... Rund Round Rond
		spitze Ecken pointed corners coins pointus 	abgerundete Ecken rounded corners coins arrondis 			
55 x 55 m.A.	129	●	●	●	●	
55 x 65	539	●	●	●	●	
55 x 85	270	●	●	●	●	
60 x 100	360	●	●	●	●	
70 x 120	311	●	●	●	●	
80 x 150	317	●	●	●	●	
80 x 80	290	●	●	●		
100 x 100	720	●	●	●		
120 x 120	728	●	●	●		
60 rund	307					●
80 rund	519					●
100 rund	521					●



Deckelbezug
Lid cover / Housse
COPERTINA

7434 ... 104
ca. 47 x 50 cm

Florhöhe (mm)
Pile height
Hauteur mèches

25



WUNSCHMASS CUSTOM DIMENSIONS DIMENSIONS SOUHAITÉES

Wählen Sie Ihr individuelles Wunschmaß von 20 x 20 cm bis zu 150 x 350 cm oder rund 20 - 200 cm.

Choose your customised dimensions from 20 x 20 cm up to 150 x 350 cm or 20 - 200 cm (round).
Sélectionnez vos dimensions personnalisées de 20 x 20 cm à 150 x 350 cm ou au format rond, de 20 à 200 cm.

qm (000)

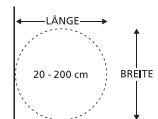
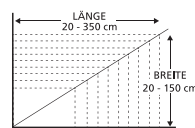

WUNSCHFARBEN CUSTOM COLOURS COULEURS SOUHAITÉES

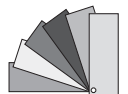

Wählen Sie aus über 100 Farben der CREATIVO-Farbpalette.

Choose from over 100 colours in the CREATIVO colour palette.
Choisissez parmi plus de 100 couleurs la palette de couleurs CREATIVO.

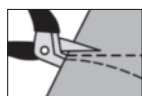

SCHABLONENFERTIGUNG TEMPLATE PRODUCTION FABRICATION D'UN PATRON

Sie benötigen eine außergewöhnliche Form? Gestalten Sie doch einfach Ihren persönlichen Badteppich ganz nach Ihren Bedürfnissen.

Do you require an unusual shape? You can still design your own customised bathmat entirely in line with your requirements.
Vous avez besoin d'une forme originale? Créez tout simplement votre tapis de bain personnel, selon vos besoins.

7458 ... 999

Für Schablonenfertigung GRANDEZZA bitte ausschließlich die Artikel-Nummer 7458 benutzen.

For GRANDEZZA template production, please only use the item number 7458.
Pour fabriquer un patron GRANDEZZA, veuillez utiliser le numéro d'article 7458.



100% Polyacryl

ANGELO



by Kleine Wolke



BELIEBTE GRÖSSEN UND FORMEN POPULAR SIZES AND SHAPES TAILLES ET FORMES POPULAIRES



8815 ... 129
ca. 55 x 55 cm



8815 ... 539
ca. 55 x 65 cm



8815 ... 270
ca. 55 x 85 cm

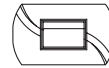

8815 ... 360
ca. 60 x 100 cm

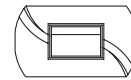

8815 ... 311
ca. 70 x 120 cm

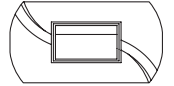

8815 ... 317
ca. 80 x 150 cm



8815 ... 290
ca. 80 x 80 cm

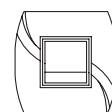

8815 ... 720
ca. 100 x 100 cm

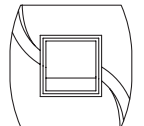

8815 ... 728
ca. 120 x 120 cm

BELIEBTE FARBEN / POPULAR COLOURS / COULEURS POPULAIRES



189 Grau



203 Korn



271 Taupe



316 Rost

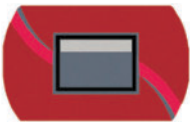

453 Rubin



568 Sunshine



617 Distel



720 Blau



8815 ... 307
ca. 60 cm rund



8815 ... 518
ca. 80 cm rund

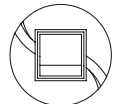

8815 ... 521
ca. 100 cm rund



Deckelbezug
COPERTINA
7434 ... 104
ca. 47 x 50 cm

Florhöhe (mm)

Pile height
Hauteur mèches

20 25

Deckelbezug (mm)

Lid cover
Housse

25

WUNSCHFARBEN / CUSTOM COLOURS / COULEURS SOUHAITÉES

Stellen Sie Ihre eigene Farbkombination zusammen.
Eine Farbübersicht finden Sie auf den Seiten 20 / 21.

Put together your own colour combination.
You can find a colour overview on pages 20 / 21.
Composez l'association de couleur de votre choix.
Retrouvez l'aperçu des couleurs aux pages 20 / 21.

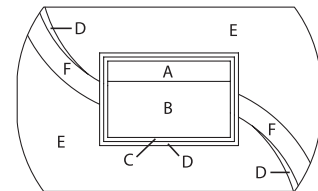
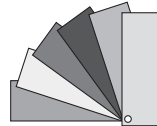

WUNSCHGRÖSSEN / CUSTOM SIZES / TAILLES SOUHAITÉES

Wählen Sie Ihr individuelles Wunschmaß von 50 x 50 cm bis zu 150 x 300 cm oder rund 50 - 150 cm.

Choose your customised dimensions from 50 x 50 cm up to 150 x 300 cm or 50 - 150 cm (round).
Sélectionnez vos dimensions personnalisées, de 50 x 50 cm à 150 x 300 cm, ou de forme ronde de 50 à 150 cm.

qm (000)

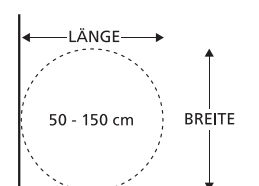
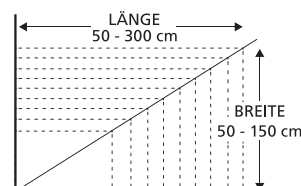

CASSETTA



BELIEBTE GRÖSSEN UND FORMEN POPULAR SIZES AND SHAPES TAILLES ET FORMES POPULAIRES



7397 ... 129
ca. 55 x 55 cm



7397 ... 539
ca. 55 x 65 cm



7397 ... 270
ca. 55 x 85 cm

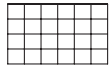

7397 ... 360
ca. 60 x 100 cm

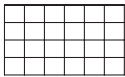

7397 ... 311
ca. 70 x 120 cm

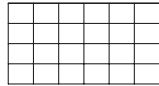

7397 ... 317
ca. 80 x 150 cm



7397 ... 290
ca. 80 x 80 cm

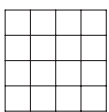

7397 ... 720
ca. 100 x 100 cm

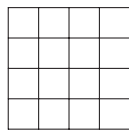

7397 ... 728
ca. 120 x 120 cm



7397 ... 307
ca. 60 cm rund



7397 ... 518
ca. 80 cm rund

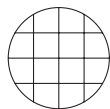

7397 ... 521
ca. 100 cm rund



Deckelbezug
COPERTINA
7434 ... 104
ca. 47 x 50 cm

Florhöhe (mm)	25
Pile height Hauteur mèches	25
Deckelbezug (mm)	25
Lid cover Housse	25



BELIEBTE FARBEN / POPULAR COLOURS / COULEURS POPULAIRES



217 Berberbeige

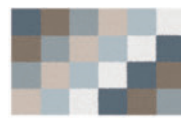

271 Taupe



453 Rubin



472 Malve



633 Minze



766 Türkis



769 Marineblau



905 Schiefer

Hinweis: Die Anzahl der Kästchen kann je nach Badteppich-Größe variieren.
Important note: The specific amount of boxes may vary, depending on the size of the bathmat.
Remarque : le nombre de cases peut varier en fonction de la taille du tapis de bain.

WUNSCHFARBEN / CUSTOM COLOURS / COULEURS SOUHAITÉES

Stellen Sie Ihre eigene Farbkombination zusammen.
Eine Farbübersicht finden Sie auf den Seiten 20 / 21.

Put together your own colour combination.
You can find a colour overview on pages 20 / 21.
Composez l'association de couleur de votre choix.
Retrouvez l'aperçu des couleurs aux pages 20 / 21.

A	B	C	D	E	F
B	C	D	E	F	A
C	D	E	F	A	B
D	E	F	A	B	C

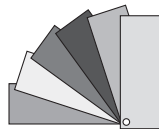

WUNSCHGRÖSSEN / CUSTOM SIZES / TAILLES SOUHAITÉES

Wählen Sie Ihr individuelles Wunschmaß von 50 x 50 cm bis zu 150 x 300 cm oder rund 50 - 150 cm.

Choose your customised dimensions from 50 x 50 cm up to 150 x 300 cm or 50 - 150 cm (round).
Sélectionnez vos dimensions personnalisées, de 50 x 50 cm à 150 x 300 cm, ou de forme ronde de 50 à 150 cm.

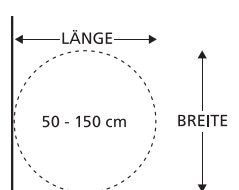
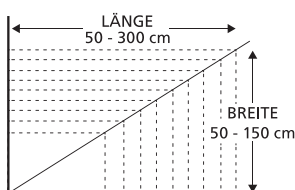

Hinweis: Anzahl und Größe der Linien sind abhängig von der Größe des Badteppichs.
Note: The number and size of the lines depends on the size of the bath mat.
Remarque : Le nombre et la taille des lignes dépendent de la taille du tapis de bain.

qm (000)



CENTRO



by Kleine Wolke

BELIEBTE GRÖSSEN UND FORMEN POPULAR SIZES AND SHAPES TAILLES ET FORMES POPULAIRES



7490 ... 129
ca. 55 x 55 cm



7490 ... 539
ca. 55 x 65 cm



7490 ... 270
ca. 55 x 85 cm



7490 ... 360
ca. 60 x 100 cm



7490 ... 311
ca. 70 x 120 cm



7490 ... 317
ca. 80 x 150 cm



7490 ... 290
ca. 80 x 80 cm

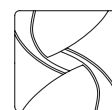

7490 ... 720
ca. 100 x 100 cm

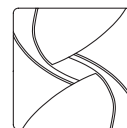

7490 ... 728
ca. 120 x 120 cm

BELIEBTE FARBEN / POPULAR COLOURS / COULEURS POPULAIRES



224 Toffee



271 Taupe



396 Lachs



431 Rouge



617 Distel



672 Türkis



798 Königsblau



977 Platin



7490 ... 307
ca. 60 cm rund



7490 ... 518
ca. 80 cm rund



7490 ... 521
ca. 100 cm rund



Deckelbezug
COPERTINA
7434 ... 104
ca. 47 x 50 cm

Florhöhe (mm)

Pile height
Hauteur mèches

20 25

Deckelbezug (mm)

Lid cover
Housse

25

WUNSCHFARBEN / CUSTOM COLOURS / COULEURS SOUHAITÉES

Stellen Sie Ihre eigene Farbkombination zusammen.
Eine Farbübersicht finden Sie auf den Seiten 20 / 21.

Put together your own colour combination.
You can find a colour overview on pages 20 / 21.
Composez l'association de couleur de votre choix.
Retrouvez l'aperçu des couleurs aux pages 20 / 21.

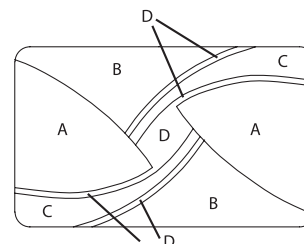
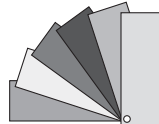

WUNSCHGRÖSSEN / CUSTOM SIZES / TAILLES SOUHAITÉES

Wählen Sie Ihr individuelles Wunschmaß von 50 x 50 cm bis zu 150 x 300 cm oder rund 50 - 150 cm.

Choose your customised dimensions from 50 x 50 cm up to 150 x 300 cm or 50 - 150 cm (round).
Sélectionnez vos dimensions personnalisées, de 50 x 50 cm à 150 x 300 cm, ou de forme ronde de 50 à 150 cm.

qm (000)

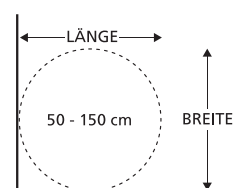
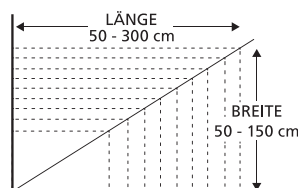

COLLINA



BELIEBTE GRÖSSEN UND FORMEN POPULAR SIZES AND SHAPES TAILLES ET FORMES POPULAIRES



7489 ... 129
ca. 55 x 55 cm



7489 ... 539
ca. 55 x 65 cm



7489 ... 270
ca. 55 x 85 cm



7489 ... 360
ca. 60 x 100 cm



7489 ... 311
ca. 70 x 120 cm



7489 ... 317
ca. 80 x 150 cm



7489 ... 290
ca. 80 x 80 cm



7489 ... 720
ca. 100 x 100 cm

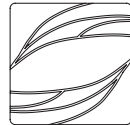

7489 ... 728
ca. 120 x 120 cm



7489 ... 307
ca. 60 cm rund



7489 ... 518
ca. 80 cm rund



7489 ... 521
ca. 100 cm rund



Deckelbezug
COPERTINA
7434 ... 104
ca. 47 x 50 cm

Florhöhe (mm) Pile height Hauteur mèches	25
Deckelbezug (mm) Lid cover Housse	25



BELIEBTE FARBEN / POPULAR COLOURS / COULEURS POPULAIRES



231 Bambusbeige



333 Brandy



451 Weinrot



633 Minze



675 Petrol



783 Mare



872 Aubergine



905 Schiefer

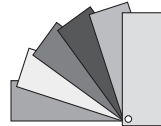
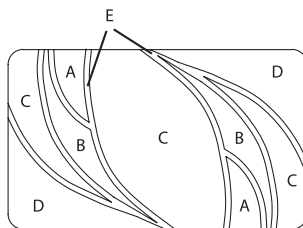

WUNSCHFARBEN / CUSTOM COLOURS / COULEURS SOUHAITÉES

Stellen Sie Ihre eigene Farbkombination zusammen.
Eine Farbübersicht finden Sie auf den Seiten 20 / 21.

Put together your own colour combination.
You can find a colour overview on pages 20 / 21.
Composez l'association de couleur de votre choix.
Retrouvez l'aperçu des couleurs aux pages 20 / 21.

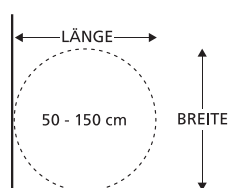
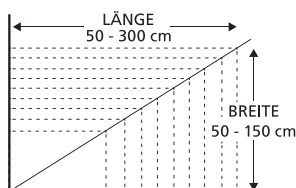

WUNSCHGRÖSSEN / CUSTOM SIZES / TAILLES SOUHAITÉES

Wählen Sie Ihr individuelles Wunschmaß von 50 x 50 cm bis zu 150 x 300 cm oder rund 50 - 150 cm.

Choose your customised dimensions from 50 x 50 cm up to 150 x 300 cm or 50 - 150 cm (round).
Sélectionnez vos dimensions personnalisées, de 50 x 50 cm à 150 x 300 cm, ou de forme ronde de 50 à 150 cm.

qm (000)

CORSO



by Kleine Wolke



BELIEBTE GRÖSSEN UND FORMEN POPULAR SIZES AND SHAPES TAILLES ET FORMES POPULAIRES



7428 ... 129
ca. 55 x 55 cm



7428 ... 539
ca. 55 x 65 cm



7428 ... 270
ca. 55 x 85 cm



7428 ... 360
ca. 60 x 100 cm

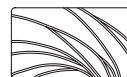

7428 ... 311
ca. 70 x 120 cm

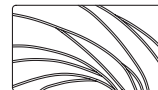

7428 ... 317
ca. 80 x 150 cm



7428 ... 290
ca. 80 x 80 cm

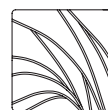

7428 ... 720
ca. 100 x 100 cm



7428 ... 728
ca. 120 x 120 cm

BELIEBTE FARBEN / POPULAR COLOURS / COULEURS POPULAIRES



271 Taupe



316 Rost



436 Beere



472 Malve



657 Tanne



675 Petrol



783 Mare



901 Anthrazit



7428 ... 307
ca. 60 cm rund



7428 ... 518
ca. 80 cm rund



7428 ... 521
ca. 100 cm rund



Deckelbezug
COPERTINA
7434 ... 104
ca. 47 x 50 cm

Florhöhe (mm)

Pile height
Hauteur mèches

20

25

Deckelbezug (mm)

Lid cover
Housse

25

WUNSCHFARBEN / CUSTOM COLOURS / COULEURS SOUHAITÉES

Stellen Sie Ihre eigene Farbkombination zusammen.
Eine Farbübersicht finden Sie auf den Seiten 20 / 21.

Put together your own colour combination.
You can find a colour overview on pages 20 / 21.
Composez l'association de couleur de votre choix.
Retrouvez l'aperçu des couleurs aux pages 20 / 21.

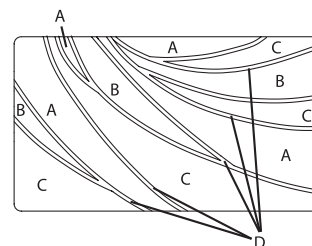
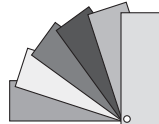

WUNSCHGRÖSSEN / CUSTOM SIZES / TAILLES SOUHAITÉES

Wählen Sie Ihr individuelles Wunschmaß von 50 x 50 cm bis zu 150 x 300 cm oder rund 50 - 150 cm.

Choose your customised dimensions from 50 x 50 cm up to 150 x 300 cm or 50 - 150 cm (round).
Sélectionnez vos dimensions personnalisées, de 50 x 50 cm à 150 x 300 cm, ou de forme ronde de 50 à 150 cm.

qm (000)

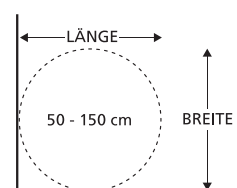
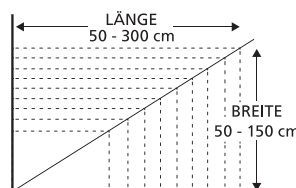



BELIEBTE GRÖSSEN UND FORMEN
POPULAR SIZES AND SHAPES
TAILLES ET FORMES POPULAIRES



8817 ... 129
ca. 55 x 55 cm



8817 ... 539
ca. 55 x 65 cm



8817 ... 270
ca. 55 x 85 cm

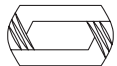

8817 ... 360
ca. 60 x 100 cm

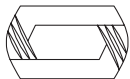

8817 ... 311
ca. 70 x 120 cm

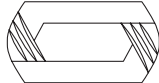

8817 ... 317
ca. 80 x 150 cm



8817 ... 290
ca. 80 x 80 cm

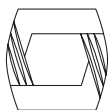

8817 ... 720
ca. 100 x 100 cm

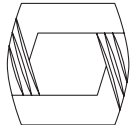

8817 ... 728
ca. 120 x 120 cm



8817 ... 307
ca. 60 cm rund



8817 ... 518
ca. 80 cm rund

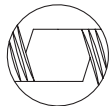

8817 ... 521
ca. 100 cm rund



Deckelbezug
COPERTINA
7434 ... 104
ca. 47 x 50 cm

Florhöhe (mm)	15
Pile height	
Hauteur mèches	
Deckelbezug (mm)	25
Lid cover	
Housse	



BELIEBTE FARBEN / POPULAR COLOURS / COULEURS POPULAIRES



189
Grau



224
Toffee



271
Taupe



322
Pfirsich



413
Pastellrose



453
Rubin



605
Alge



769
Marineblau

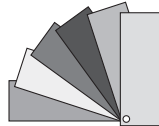
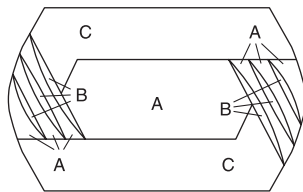

WUNSCHFARBEN / CUSTOM COLOURS / COULEURS SOUHAITÉES

Stellen Sie Ihre eigene Farbkombination zusammen.
Eine Farbübersicht finden Sie auf den Seiten 20 / 21.

Put together your own colour combination.
You can find a colour overview on pages 20 / 21.
Composez l'association de couleur de votre choix.
Retrouvez l'aperçu des couleurs aux pages 20 / 21.

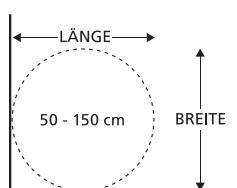
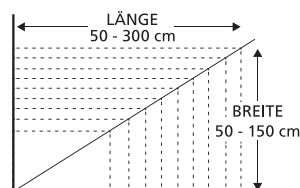

Wählen Sie Ihr individuelles Wunschmaß von 50 x 50 cm bis zu 150 x 300 cm oder rund 50 - 150 cm.

Choose your customised dimensions from 50 x 50 cm up to 150 x 300 cm or 50 - 150 cm (round).
Sélectionnez vos dimensions personnalisées, de 50 x 50 cm à 150 x 300 cm, ou de forme ronde de 50 à 150 cm.

qm (000)

HARMONIA



by Kleine Wolke

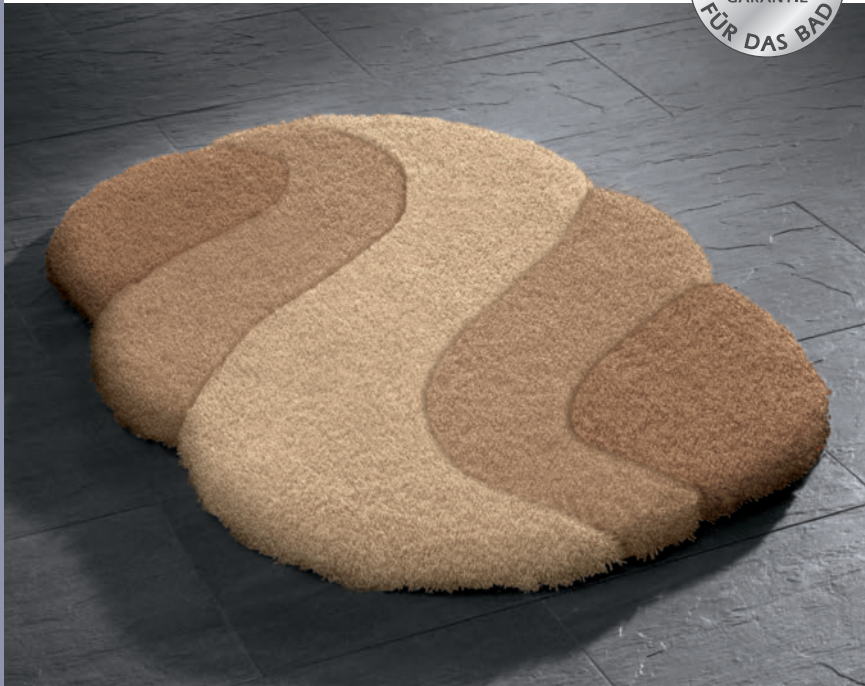

BELIEBTE GRÖSSEN UND FORMEN POPULAR SIZES AND SHAPES TAILLES ET FORMES POPULAIRES



8968 ... 129
ca. 55 x 55 cm



8968 ... 539
ca. 55 x 65 cm



8968 ... 270
ca. 55 x 85 cm



8968 ... 360
ca. 60 x 100 cm



8968 ... 311
ca. 70 x 120 cm



8968 ... 317
ca. 80 x 150 cm



8968 ... 290
ca. 80 x 80 cm



8968 ... 720
ca. 100 x 100 cm



8968 ... 728
ca. 120 x 120 cm



8968 ... 307
ca. 60 cm rund



8968 ... 518
ca. 80 cm rund



8968 ... 521
ca. 100 cm rund



Deckelbezug
COPERTINA
7434 ... 104
ca. 47 x 50 cm

Florhöhe (mm)

Pile height
Hauteur mèches

15 25

Deckelbezug (mm)

Lid cover
Housse

25

BELIEBTE FARBEN / POPULAR COLOURS / COULEURS POPULAIRES



224 Toffee



272 Macadamia



319 Aprikose



442 Flamingo



453 Rubin



602 Klee



720 Blau



901 Anthrazit

WUNSCHFARBEN / CUSTOM COLOURS / COULEURS SOUHAITÉES

Stellen Sie Ihre eigene Farbkombination zusammen.
Eine Farbübersicht finden Sie auf den Seiten 20 / 21.

Put together your own colour combination.
You can find a colour overview on pages 20 / 21.
Composez l'association de couleur de votre choix.
Retrouvez l'aperçu des couleurs aux pages 20 / 21.

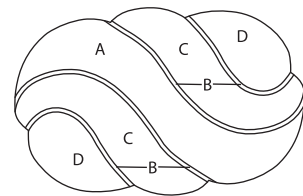
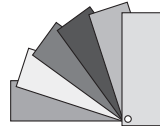

WUNSCHGRÖSSEN / CUSTOM SIZES / TAILLES SOUHAITÉES

Wählen Sie Ihr individuelles Wunschmaß von 50 x 50 cm bis zu 150 x 300 cm oder rund 50 - 150 cm.

Choose your customised dimensions from 50 x 50 cm up to 150 x 300 cm or 50 - 150 cm (round).
Sélectionnez vos dimensions personnalisées, de 50 x 50 cm à 150 x 300 cm, ou de forme ronde de 50 à 150 cm.

qm (000)

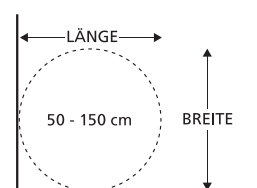
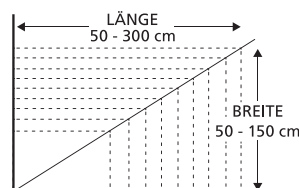



BELIEBTE GRÖSSEN UND FORMEN
POPULAR SIZES AND SHAPES
TAILLES ET FORMES POPULAIRES



8964 ... 129
ca. 55 x 55 cm



8964 ... 539
ca. 55 x 65 cm

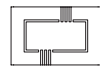

8964 ... 270
ca. 55 x 85 cm

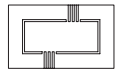

8964 ... 360
ca. 60 x 100 cm

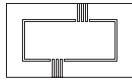

8964 ... 311
ca. 70 x 120 cm

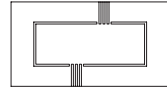

8964 ... 317
ca. 80 x 150 cm



8964 ... 290
ca. 80 x 80 cm

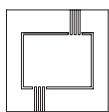

8964 ... 720
ca. 100 x 100 cm

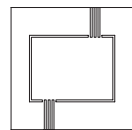

8964 ... 728
ca. 120 x 120 cm



8964 ... 307
ca. 60 cm rund



8964 ... 518
ca. 80 cm rund

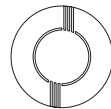

8964 ... 521
ca. 100 cm rund



Deckelbezug
COPERTINA
7434 ... 104
ca. 47 x 50 cm

Florhöhe (mm)	20	25
Pile height		
Hauteur mèches		
Deckelbezug (mm)	25	
Lid cover		
Housse		



BELIEBTE FARBEN / POPULAR COLOURS / COULEURS POPULAIRES



189 Grau



271 Taupe



316 Rost



468 Granat



539 Safran



617 Distel



789 Dunkelblau

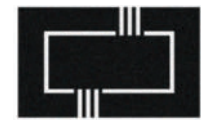

926 Schwarz

WUNSCHFARBEN / CUSTOM COLOURS / COULEURS SOUHAITÉES

Stellen Sie Ihre eigene Farbkombination zusammen.
Eine Farbübersicht finden Sie auf den Seiten 20 / 21.

Put together your own colour combination.
You can find a colour overview on pages 20 / 21.
Composez l'association de couleur de votre choix.
Retrouvez l'aperçu des couleurs aux pages 20 / 21.

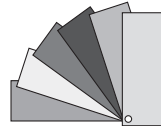
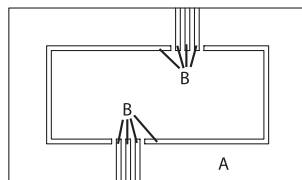

WUNSCHGRÖSSEN / CUSTOM SIZES / TAILLES SOUHAITÉES

Wählen Sie Ihr individuelles Wunschmaß von 50 x 50 cm bis zu 150 x 300 cm oder rund 50 - 150 cm.

Choose your customised dimensions from 50 x 50 cm up to 150 x 300 cm or 50 - 150 cm (round).
Sélectionnez vos dimensions personnalisées, de 50 x 50 cm à 150 x 300 cm, ou de forme ronde de 50 à 150 cm.

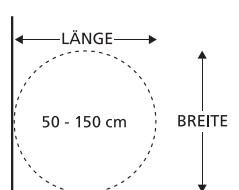
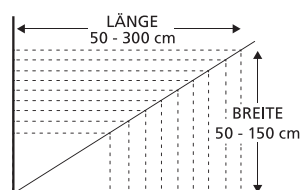

qm (000)

MEANDRO



by Kleine Wolke



BELIEBTE GRÖSSEN UND FORMEN POPULAR SIZES AND SHAPES TAILLES ET FORMES POPULAIRES



7399 ... 129
ca. 55 x 55 cm



7399 ... 539
ca. 55 x 65 cm



7399 ... 270
ca. 55 x 85 cm

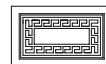

7399 ... 360
ca. 60 x 100 cm

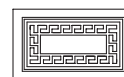

7399 ... 311
ca. 70 x 120 cm

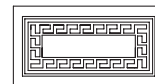

7399 ... 317
ca. 80 x 150 cm



7399 ... 290
ca. 80 x 80 cm

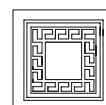

7399 ... 720
ca. 100 x 100 cm

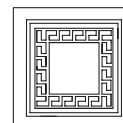

7399 ... 728
ca. 120 x 120 cm

BELIEBTE FARBEN / POPULAR COLOURS / COULEURS POPULAIRES



217 Berberbeige



271 Taupe



316 Rost



436 Beere



468 Granat



617 Distel



769 Marineblau

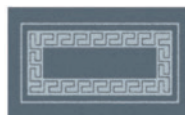

901 Anthrazit



7399 ... 307
ca. 60 cm rund



7399 ... 518
ca. 80 cm rund



7399 ... 521
ca. 100 cm rund



Deckelbezug
COPERTINA
7434 ... 104
ca. 47 x 50 cm

Florhöhe (mm)

Pile height

Hauteur mèches

15

Deckelbezug (mm)

Lid cover

Housse

25

WUNSCHFARBEN / CUSTOM COLOURS / COULEURS SOUHAITÉES

Stellen Sie Ihre eigene Farbkombination zusammen.
Eine Farbübersicht finden Sie auf den Seiten 20 / 21.

Put together your own colour combination.
You can find a colour overview on pages 20 / 21.
Composez l'association de couleur de votre choix.
Retrouvez l'aperçu des couleurs aux pages 20 / 21.

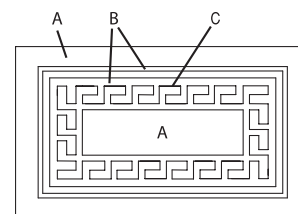
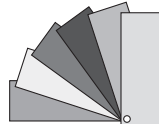

WUNSCHGRÖSSEN / CUSTOM SIZES / TAILLES SOUHAITÉES

Wählen Sie Ihr individuelles Wunschmaß von 50 x 50 cm bis zu 150 x 300 cm oder rund 50 - 150 cm.

Choose your customised dimensions from 50 x 50 cm up to 150 x 300 cm or 50 - 150 cm (round).
Sélectionnez vos dimensions personnalisées, de 50 x 50 cm à 150 x 300 cm, ou de forme ronde de 50 à 150 cm.

qm (000)

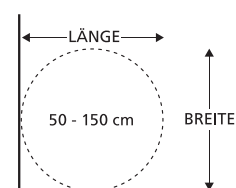
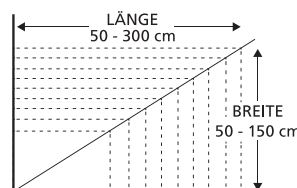

MELODIA



BELIEBTE GRÖSSEN UND FORMEN POPULAR SIZES AND SHAPES TAILLES ET FORMES POPULAIRES



7727 ... 129
ca. 55 x 55 cm



7727 ... 539
ca. 55 x 65 cm



7727 ... 270
ca. 55 x 85 cm

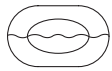

7727 ... 360
ca. 60 x 100 cm

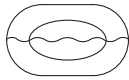

7727 ... 311
ca. 70 x 120 cm

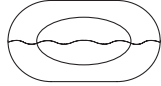

7727 ... 317
ca. 80 x 150 cm



7727 ... 290
ca. 80 x 80 cm

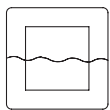

7727 ... 720
ca. 100 x 100 cm

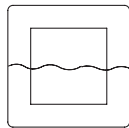

7727 ... 728
ca. 120 x 120 cm



7727 ... 307
ca. 60 cm rund



7727 ... 518
ca. 80 cm rund

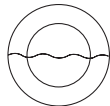

7727 ... 521
ca. 100 cm rund



Deckelbezug
COPERTINA
7434 ... 104
ca. 47 x 50 cm

Florhöhe (mm)	20	25
Pile height		
Hauteur mèches		
Deckelbezug (mm)	25	
Lid cover		
Housse		



BELIEBTE FARBEN / POPULAR COLOURS / COULEURS POPULAIRES



146 Silbergrau



231 Bambusbeige



271 Taupe



396 Lachs



468 Granat



472 Malve



569 Goldgelb



799 Royalblau

WUNSCHFARBEN / CUSTOM COLOURS / COULEURS SOUHAITÉES

Stellen Sie Ihre eigene Farbkombination zusammen.
Eine Farbübersicht finden Sie auf den Seiten 20 / 21.

Put together your own colour combination.
You can find a colour overview on pages 20 / 21.
Composez l'association de couleur de votre choix.
Retrouvez l'aperçu des couleurs aux pages 20 / 21.

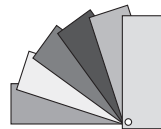
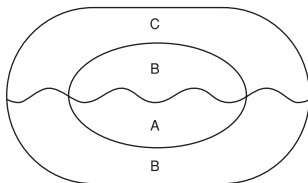

WUNSCHGRÖSSEN / CUSTOM SIZES / TAILLES SOUHAITÉES

Wählen Sie Ihr individuelles Wunschmaß von 50 x 50 cm bis
zu 150 x 300 cm oder rund 50 - 150 cm.

Choose your customised dimensions from 50 x 50 cm
up to 150 x 300 cm or 50 - 150 cm (round).
Sélectionnez vos dimensions personnalisées, de 50 x 50 cm à 150 x 300 cm,
ou de forme ronde de 50 à 150 cm.

qm (000)

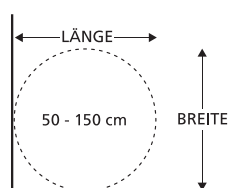
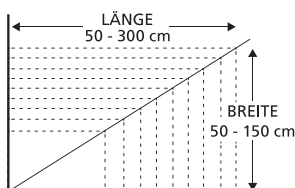

MITILO



by Kleine Wolke

BELIEBTE GRÖSSEN UND FORMEN POPULAR SIZES AND SHAPES TAILLES ET FORMES POPULAIRES



7367 ... 175
ca. 50 x 60 cm



7367 ... 223
ca. 50 x 60 cm



7367 ... 539
ca. 55 x 65 cm



7367 ... 457
ca. 65 x 80 cm



7367 ... 280
ca. 80 x 100 cm



7367 ... 628
ca. 95 x 120 cm

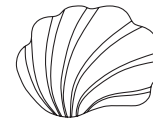

7367 ... 629
ca. 110 x 140 cm

BELIEBTE FARBEN / POPULAR COLOURS / COULEURS POPULAIRES



158 Auster



226 Sandbeige



272 Macadamia



319 Aprikose



415 Koralle



443 Magnolie



619 Linde



738 Hellblau



Deckelbezug
COPERTINA
7434 ... 104
ca. 47 x 50 cm

Florhöhe (mm)

Pile height
Hauteur mèches

25

Deckelbezug (mm)

Lid cover
Housse

25

WUNSCHFARBEN / CUSTOM COLOURS / COULEURS SOUHAITÉES

Stellen Sie Ihre eigene Farbkombination zusammen.
Eine Farbübersicht finden Sie auf den Seiten 20 / 21.

Put together your own colour combination.
You can find a colour overview on pages 20 / 21.
Composez l'association de couleur de votre choix.
Retrouvez l'aperçu des couleurs aux pages 20 / 21.

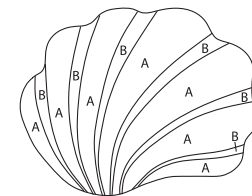
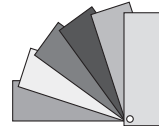

WUNSCHGRÖSSEN / CUSTOM SIZES / TAILLES SOUHAITÉES

Wählen Sie Ihr individuelles Wunschmaß von 50 x 50 cm bis zu 150 x 300 cm oder rund 50 - 150 cm.

Choose your customised dimensions from 50 x 50 cm up to 150 x 300 cm or 50 - 150 cm (round).
Sélectionnez vos dimensions personnalisées, de 50 x 50 cm à 150 x 300 cm, ou de forme ronde de 50 à 150 cm.

qm (000)

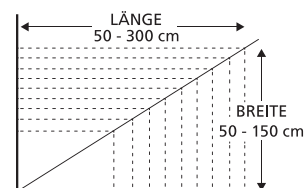

VALLETTA



BELIEBTE GRÖSSEN UND FORMEN POPULAR SIZES AND SHAPES TAILLES ET FORMES POPULAIRES



7491 ... 129
ca. 55 x 55 cm



7491 ... 539
ca. 55 x 65 cm



7491 ... 270
ca. 55 x 85 cm



7491 ... 428
ca. 65 x 100 cm



7491 ... 449
ca. 75 x 120 cm



7491 ... 277
ca. 90 x 150 cm



7491 ... 290
ca. 80 x 80 cm



7491 ... 720
ca. 100 x 100 cm



7491 ... 728
ca. 120 x 120 cm



7491 ... 307
ca. 60 cm rund



7491 ... 518
ca. 80 cm rund



7491 ... 521
ca. 100 cm rund



Deckelbezug
COPERTINA
7434 ... 104
ca. 47 x 50 cm

Florhöhe (mm)	25
Pile height Hauteur mèches	25
Deckelbezug (mm)	25
Lid cover Housse	25



BELIEBTE FARBEN / POPULAR COLOURS / COULEURS POPULAIRES



272 Macadamia



322 Pfirsich



327 Marsala



413 Pastellrose



431 Rouge



617 Distel



754 Iceblue



977 Platin

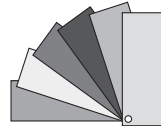
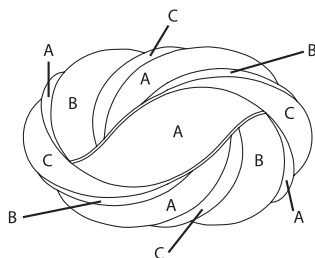

WUNSCHFARBEN / CUSTOM COLOURS / COULEURS SOUHAITÉES

Stellen Sie Ihre eigene Farbkombination zusammen.
Eine Farbübersicht finden Sie auf den Seiten 20 / 21.

Put together your own colour combination.
You can find a colour overview on pages 20 / 21.
Composez l'association de couleur de votre choix.
Retrouvez l'aperçu des couleurs aux pages 20 / 21.

WUNSCHGRÖSSEN / CUSTOM SIZES / TAILLES SOUHAITÉES

Wählen Sie Ihr individuelles Wunschmaß von 50 x 50 cm bis zu 150 x 300 cm.

Choose your customised dimensions from 50 x 50 cm up to 150 x 300 cm.
Sélectionnez vos dimensions personnalisées, de 50 x 50 cm à 150 x 300 cm.

qm (000)

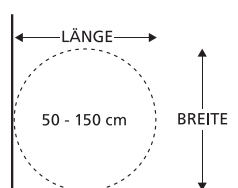
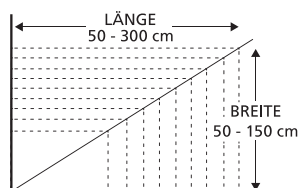

BADTEPPICHE SEITE 38-89

Bath rugs 38-89 / Tapis de bain 38-89

						
RELAX 38-39	BEACH 40	BLOOM 41	NEW BOLA 42	CARO 43	NEW CARLA 44	CASSY 45
						
CELINE 46	NEW CONY 47	CORY 48	COSIMA 49	CUBETTO 50	DAKOTA 51	FIESTA 52
						
NEW COLOUR COULEUR FIONA 53	NEW HAILEY 54	HELENA 55	INSPIRE 56	NEW ISA 57	JULIE 58	NEW LEXY 59
						
LOUNGE 60	NEW MAGIC 61	NEW MAINE 62	NEW MALIN 63	MANDALA 64	NEW COLOUR COULEUR MEADOW 65	MIAMI 66
						
MIX 67	MONROVIA 68	NELLI 69	OSLO 70	RIVA 71	RUMBA 72	SEATTLE 73
						
SEAWORLD 74	SIESTA 75	SIGMA 76	SPLASH 77	NEW STELLA 78	NEW SURI 79	TENDER 80
						
NEW TIRA 81	TIVOLI 82	TREND 83	NEW COLOUR COULEUR TWIN 84	VANESSA 85	NEW COLOUR COULEUR WAVE 86	NEW COLOUR COULEUR WILLOW 87
						
NEW COLOUR COULEUR WILNA 88	NEW COLOUR COULEUR SOFT DECKEL 89	ANTI-RUTSCH 89				

Qualitätsmerkmale für Badteppiche, Frottierwaren und Holzmatten

Quality features for bath rugs, terry cloth and wooden mats
Caractéristiques de qualité pour tapis de bain, tissu-éponge et tapis en bois

- **Synthetik-Materialien:** pflegeleicht, schnelltrocknend, abriebfest
- **Natur-Materialien:** Naturprodukt, hohe Wasseraufnahme, hautverträglich
- hochwertige Florgarne, ausgewählte Trägermaterialien, haltbare Rückenbeschichtungen
- strenge Qualitätskontrolle für Garne, Farbechtheiten und Alterungsbeständigkeit der Beschichtungen
- eine Vielzahl der Badteppiche sind mit einer hochwertigen, rutschhemmenden TPE-Beschichtung ausgestattet
- alle Badteppiche werden ausschließlich in Ländern produziert, die nach dem amfori BSCI Code of Conduct auditiert sind
- umweltfreundlich und schadstofffrei

- **Synthetic materials:** easy to clean, fast drying, abrasion-resistant
- **Natural materials:** natural product, high water absorption, does not cause skin irritation
- high-quality weft thread, select base materials, durable back coatings
- strict quality controls for threads, colour fastness and durability of the coatings
- a wide range of bathroom rugs are fitted with a high-quality, slip-resistant TPE coating
- all bathroom rugs are produced exclusively in countries audited according to the amfori BSCI Code of Conduct
- environmentally friendly and pollutant-free

- **Matériaux synthétiques:** faciles à entretenir, séchage rapide, antiabrasifs
- **Matériaux naturels:** produits naturels, très haute capacité d'absorption, agréables au toucher
- étoffe filée de haute qualité, matériaux de support soigneusement sélectionnés, revêtement longue durée sur l'endos
- contrôle strict de la qualité des fils résistance des couleurs et du revêtement anti-dérapant
- un grand éventail de tapis de bain, équipés d'un revêtement antidérapant en TPE de qualité supérieure
- tous les tapis de bain sont exclusivement produits dans des pays ayant passé un audit conformément au Code de conduite de amfori BSCI
- écologique et exempt de substances nocives

BADTEPPICHE SEITE 90-110

Bath rugs 90-110 / Tapis de bain 90-110



FROTTIER + HOLZMATTEN SEITE 111-117

Terry cloth + wooden mats 111-117 / Eponge + tapis en bois 111-117



Wunderschön und zeitlos elegant

Das Badteppich-Modell **RELAX** überzeugt im Besonderen durch seine außergewöhnliche Melange-Optik. Über 20 mögliche Melange-Farben* stehen zur Verfügung. Das Uni-Programm bietet neben vielen Größen und Formen auch Badteppiche in individueller Wunschmaß-Fertigung.

* 115 Polarweiß und 926 Schwarz sind nicht meliert.

The RELAX model is particularly appreciated by customers thanks to its unusual blended look. Over 20 possible melange colours* are available. In addition to many sizes and shapes, the plain programme also offers bathroom carpets in individual custom-made designs.

* 115 polar white and 926 black are not mottled.

Le modèle RELAX se distingue grâce à son apparence chinée si exceptionnelle. Plus de 20 couleurs de mélange possibles* sont disponibles. En plus de nombreuses tailles et formes, le programme simple propose également des tapis de salle de bains au design personnalisé.

* 115 Polarweiß und 926 Schwarz: non chiné.





5405 ... 104
ca. 47 x 50 cm



5405 ... 129
ca. 55 x 55 cm



5405 ... 539
ca. 55 x 65 cm

5405 ... 207
ca. 50 x 80 cm

5405 ... 360
ca. 60 x 100 cm

5405 ... 225
ca. 70 x 120 cm

5405 ... 453
ca. 85 x 150 cm



5405 ... 307
ca. 60 cm rund

5405 ... 518
ca. 80 cm rund

5405 ... 521
ca. 100 cm rund



Custom dimensions
Dimensions souhaitées

5405 ... 000
1 qm

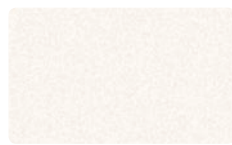

115*
Polarweiß



189
Grau



220
Champagner



264
Walnuss

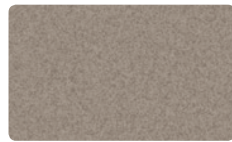

271
Taupe



291
Bast



311
Mahagoni



316
Rost



332
Rosenholz



413
Pastellrose



453
Rubin

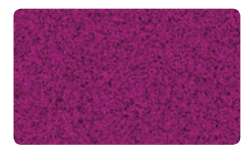

461
Purple



569
Goldgelb



615
Kiwigrün

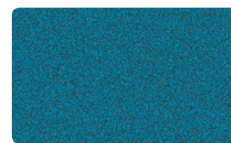

663
Pazifik



672
Türkis



723
Azur

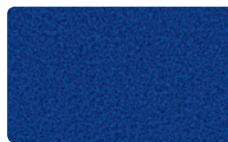

736
Atlantikblau



858
Crocus

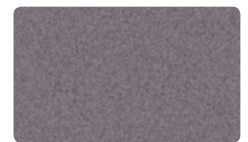

901
Anthrazit



926*
Schwarz

*Nicht meliert
*Not mottled
*Non chiné

100% Polyacryl



Florhöhe (mm)
Pile height
Hauteur mèches

30

Deckelbezug (mm)
Lid cover
Housse

20

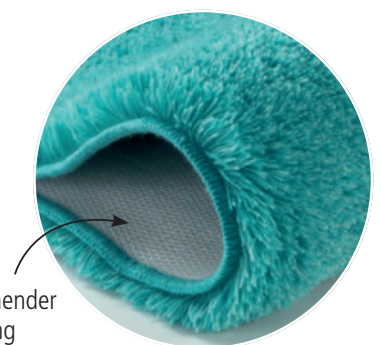

Mit rutschhemmender
TPE-Beschichtung

Equipped with an anti-slip TPE-coating
Avec revêtement TPE antidérapant

Weitere Formen finden Sie im Creativo-Teil Seite 18-19
You can find other shapes in the CREATIVO section, pages 18/19
Retrouvez d'autres formes dans la section Creativo, aux pages 18/19.

BEACH



2-farbige Motive mit Hoch-Tiefeffekt
 2-colored motifs with high-low effect
 Motifs bicolores avec effet haut-bas

Mit rutschhemmender TPE-Beschichtung
 Equipped with an anti-slip TPE-coating
 Avec revêtement TPE antidérapant

100% Polyacryl



Florhöhe (mm)
 Pile height
 Hauteur mèches



Deckelbezug (mm)
 Lid cover
 Housse



158
 Auster
 * 114 Schneeweiß



226
 Sandbeige
 * 114 Schneeweiß



316
 Rost
 * 316 Rost



723
 Azur
 * 769 Marineblau



8888 ... 104
 ca. 47 x 50 cm



4581 ... 150
 ca. 50 x 50 cm



4581 ... 357
 ca. 55 x 65 cm



4581 ... 360
 ca. 60 x 100 cm

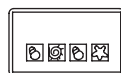

4581 ... 225
 ca. 70 x 120 cm



Das passt dazu:
That fits: / Ça correspond:

Mit rutschhemmender TPE-Beschichtung
Equipped with an anti-slip TPE-coating
Avec revêtement TPE antidérapant



BLOOM
PEVA-Duschvorhang
im Art-Deco Stil
PEVA shower curtain in
Art Deco style
Rideau de douche PEVA
de style Art déco
> Seite 217 / page 217

100% Polyacryl



Florhöhe (mm)
Pile height
Hauteur mèches

20

Deckelbezug (mm)
Lid cover
Housse

20



398
Pearl
* 114 Schneeweiß



607
Salbeigrün
* 114 Schneeweiß



746
Stahlblau
* 754 Iceblue



8888 ... 104*
ca. 47 x 50 cm



9119 ... 539
ca. 55 x 65 cm



9119 ... 519
ca. 60 x 90 cm



9119 ... 225
ca. 70 x 120 cm

BLOOM
Accessoire-Serie
im Art-Deco Stil

Accessory series
in Art Deco style
Série d'accessoires
dans le style Art Deco
> Seite 123 / page 123





Junger modischer Teppich
im Streifendesign
Young fashionable carpet in striped design
Un tapis à la mode en dessin rayé

100% Polyester



Florhöhe (mm)
Pile height
Hauteur mèches

18

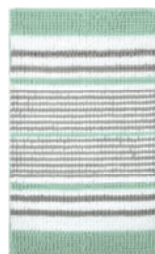

685
Maledivia



783
Mare

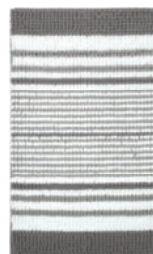

901
Anthrazit



9143 ... 539
ca. 55 x 65 cm

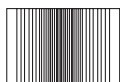

9143 ... 519
ca. 60 x 90 cm

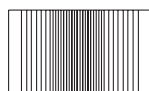

9143 ... 225
ca. 70 x 120 cm



Mit rutschhemmender TPE-Beschichtung
 Equipped with an anti-slip TPE-coating
 Avec revêtement TPE antidérapant

100% Polyacryl



Florhöhe (mm)
 Pile height
 Hauteur mèches



Deckelbezug (mm)
 Lid cover
 Housse



179
 Flanell
 *901 Anthrazit



287
 Kaschmir
 *114 Schneeweiß



407
 Old Rose
 *436 Beere



414
 Salmon
 *114 Schneeweiß



617
 Distel
 *114 Schneeweiß



675
 Petrol
 *675 Petrol



783
 Mare
 *754 Iceblue



8888 ... 104*
 ca. 47 x 50 cm



5426 ... 129
 ca. 55 x 55 cm



5426 ... 539
 ca. 55 x 65 cm



5426 ... 382
 ca. 60 x 105 cm

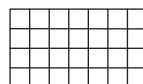

5426 ... 225
 ca. 70 x 120 cm

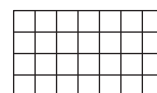

5426 ... 453
 ca. 85 x 150 cm



Badteppich im Streifen-design und Hoch-/Tiefoptik
 With high/low optics
 Avec une optique haute/basse

Mit rutschhemmender TPE-Beschichtung
 Equipped with an anti-slip TPE-coating
 Avec revêtement TPE antidérapant

100% Polyester



Florhöhe (mm)
 Pile height
 Hauteur mèches



100
Weiß



146
Silbergrau



226
Sandbeige



398
Pearl



9141 ... 430
ca. 55 x 60 cm



9141 ... 360
ca. 60 x 100 cm



9141 ... 484
ca. 70 x 110 cm

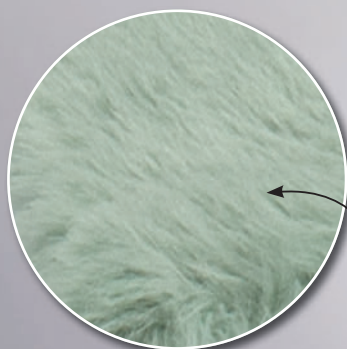

Mit extravaganter Felloptik
With luxurious fur look
Imitation fourrure extravagante

100% Polyacryl



Florhöhe (mm)
Pile height
Hauteur mèches



401
Nelke



685
Maledivia



913
Nebel



Mit rutschhemmender
TPE-Beschichtung
Equipped with an anti-slip
TPE-coating
Avec revêtement TPE
antidérapant

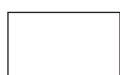

9123 ... 360
ca. 60 x 100 cm



Uni-Teppich aus groben Schlingen
mit weicher Haptik
Plain bath rug made of coarse loops with soft haptics
Tapis de bain uni fait de boucles grossières avec haptique douce

70% Polyester + 30% Cotton



Florhöhe (mm)
Pile height
Hauteur mèches

40



146
Silbergrau



332
Rosenholz



698
Eukalyptus



783
Mare



9120 ... 135
ca. 60 x 60 cm



9120 ... 360
ca. 60 x 100 cm

NEW



Mit rutschhemmender TPE-Beschichtung
Equipped with an anti-slip TPE-coating
Avec revêtement TPE antidérapant

DESIGNWELT
Magical Moments



100% Polyester



Florhöhe (mm)
Pile height
Hauteur mèches

25



201
Beige



352
Kastanie



398
Pearl



436
Beere



569
Goldgelb



783
Mare



9139 ... 539
ca. 55 x 65 cm



9139 ... 360
ca. 60 x 100 cm



9139 ... 225
ca. 70 x 120 cm

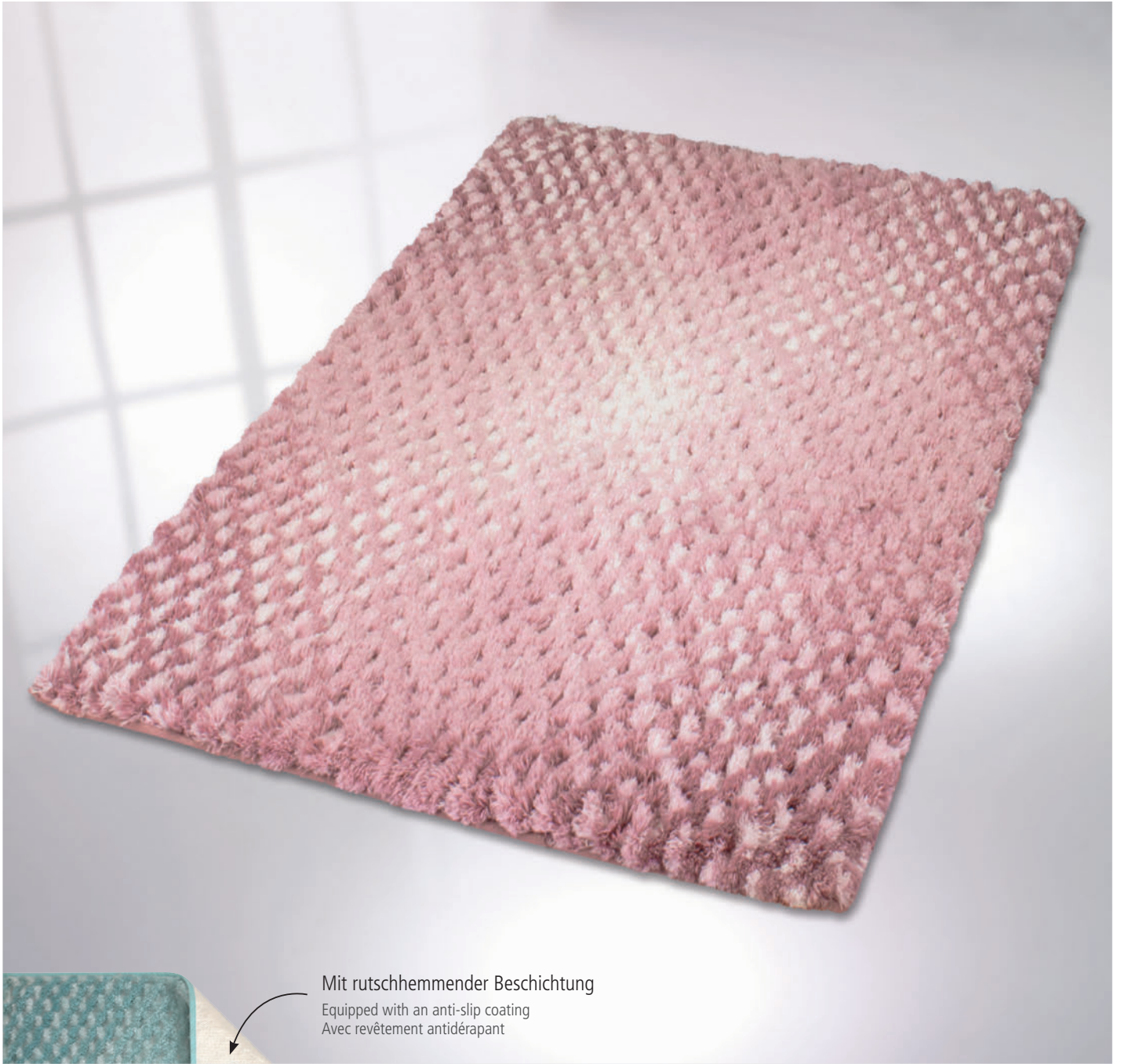

Mit rutschhemmender Beschichtung

Equipped with an anti-slip coating
Avec revêtement antidérapant



100% Polyester



Florhöhe (mm)
Pile height
Hauteur mèches

24



407
Old Rose

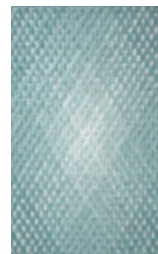

652
Schilf

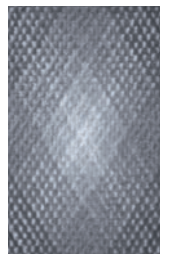

901
Anthrazit



9121 ... 135
ca. 60 x 60 cm



9121 ... 360
ca. 60 x 100 cm



9121 ... 225
ca. 70 x 120 cm



Mit rutschhemmender TPE-Beschichtung

Equipped with an anti-slip TPE-coating
Avec revêtement TPE antidérapant

100% Polyacryl



Florhöhe (mm)

Pile height
Hauteur mèches

20

Deckelbezug (mm)

Lid cover
Housse

20



272
Macadamia



672
Türkis
*675 Petrol



712
Sorr.-Azurblau



901
Anthrazit
*901 Anthrazit



8888 ... 104*
ca. 47 x 50 cm



9103 ... 539
ca. 55 x 65 cm

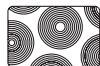

9103 ... 519
ca. 60 x 90 cm



9103 ... 225
ca. 70 x 120 cm

CUBETTO



Mit rutschhemmender TPE-Beschichtung
 Equipped with an anti-slip TPE-coating
 Avec revêtement TPE antidérapant

100% Polyacryl



Florhöhe (mm)
 Pile height
 Hauteur mèches

25



148
 Multicolor



8821 ... 144
 ca. 60 x 60 cm



8821 ... 135
 ca. 60 x 60 cm

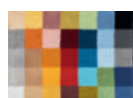

8821 ... 213
 ca. 65 x 90 cm



8821 ... 449
 ca. 75 x 120 cm



8821 ... 693
 ca. 85 x 145 cm



8821 ... 528
 ca. 90 cm rund



100% Polyacryl



Florhöhe (mm)

Pile height
Hauteur mèches

20

Deckelbezug (mm)

Lid cover
Housse

20



453
Rubin

* 453 Rubin



769
Marineblau

* 769 Marineblau



977
Platin

* 977 Platin



8888 ... 104
ca. 47 x 50 cm



4598 ... 539
ca. 55 x 65 cm



4598 ... 519
ca. 60 x 90 cm

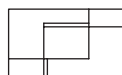

4598 ... 225
ca. 70 x 120 cm

FIESTA

MICROFASER



100% Polyacryl / Microfaser



Florhöhe (mm)
Pile height
Hauteur mèches

22

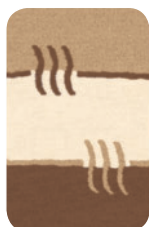

231
Bambusbeige



4594 ... 150
ca. 50 x 50 cm



4594 ... 313
ca. 50 x 65 cm

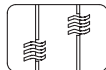

4594 ... 519
ca. 60 x 90 cm

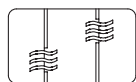

4594 ... 225
ca. 70 x 120 cm

Neue
Farben
New colours
Nouvelles
couleurs

Badteppich im
Farbverlauf mit
Hoch-/Tiefoptik

Bathroom rug featuring a
colour gradient with
high/low optic
Tapis de bain avec dégradé
de couleurs et effet de
relief/profondeur

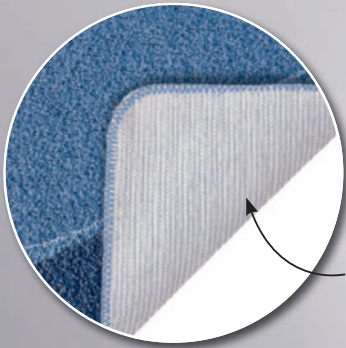

Mit rutschhemmender TPE-Beschichtung

Equipped with an anti-slip TPE-coating
Avec revêtement TPE antidérapant

100% Polyacryl



Florhöhe (mm)

Pile height
Hauteur mèches



Deckelbezug (mm)

Lid cover
Housse

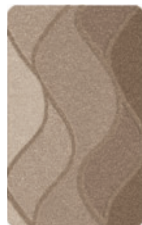

287
Kaschmir
*271 Taupe



334
Chili

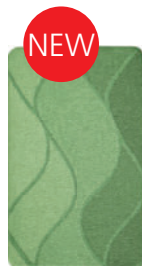

617
Distel
*619 Linde



675
Petrol
*675 Petrol



754
Iceblue
*754 Iceblue

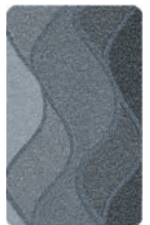

905
Schiefer
*901 Anthrazit



8888 ... 104*
ca. 47 x 50 cm



9128 ... 130
ca. 55 x 50 cm



9128 ... 539
ca. 55 x 65 cm

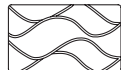

9128 ... 360
ca. 60 x 100 cm

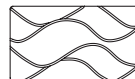

9128 ... 225
ca. 70 x 120 cm

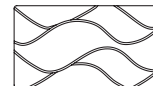

9128 ... 657
ca. 80 x 140 cm



Badteppich mit Hoch-/Tiefeffekt
With high/low optics
Avec une optique haute/basse

Mit rutschhemmender TPE-Beschichtung
Equipped with an anti-slip TPE-coating
Avec revêtement TPE antidérapant

100% Polyacryl



Florhöhe (mm)
Pile height
Hauteur mèches



Deckelbezug (mm)
Lid cover
Housse



271
Taupe
*271 Taupe



327
Marsala



754
Iceblue
*754 Iceblue



926
Schwarz
*901 Anthrazit



8888 ... 104*
ca. 47 x 50 cm



9132 ... 130
ca. 55 x 50 cm



9132 ... 539
ca. 55 x 65 cm



9132 ... 360
ca. 60 x 100 cm



9132 ... 225
ca. 70 x 120 cm



9132 ... 657
ca. 80 x 140 cm

MICROFASER

Mit rutschhemmender TPE-Beschichtung

Equipped with an anti-slip TPE-coating
Avec revêtement TPE antidérapant



Badteppich
mit Hoch-/ Tiefoptik
Bath rug with high-low effect
Tapis de bain avec effet haut-bas

100% Polyester / Microfaser



Florhöhe (mm)

Pile height
Hauteur mèches

10 15

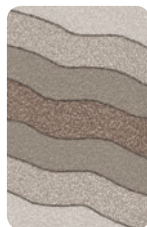

287
Kaschmir

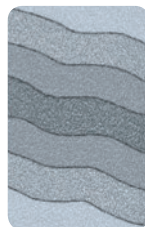

905
Schiefer



5532 ... 433
ca. 50 x 60 cm

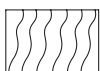

5532 ... 519
ca. 60 x 90 cm



5532 ... 225
ca. 70 x 120 cm

12-Nadeltechnik in ansprechender Steinoptik
und harmonischem Farbverlauf

12-needle technique with appealing stone
look and harmonious colour gradient
Technique à l'aiguille de 12 pour créer cet
effet de roches et ce dégradé de couleurs
harmonieux

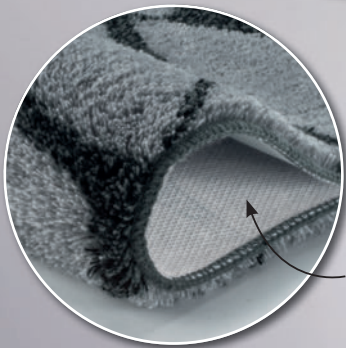

Mit rutschhemmender TPE-Beschichtung

Equipped with an anti-slip TPE-coating
Avec revêtement TPE antidérapant

100% Polyacryl



Florhöhe (mm)

Pile height
Hauteur mèches

15

Deckelbezug (mm)

Lid cover
Housse

20

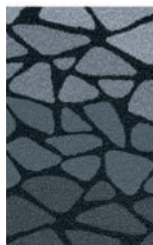

905
Schiefer
*901 Anthrazit



8888 ... 104*
ca. 47 x 50 cm



4085 ... 135
ca. 60 x 60 cm

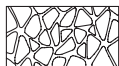

4085 ... 360
ca. 60 x 100 cm



4085 ... 225
ca. 70 x 120 cm

Das passt dazu:

That fits: / Ça correspond:

CRACKLE

Accessoire-Serie mit 3D-Struktur

Accessory series with 3D structure
Série d'accessoires avec structure 3D

> Seite 128 / page 128

NEW
COLOUR
COULEUR



CLAP
Schwingdeckeleimer, 5 Liter

Swing bin, 5 litres
Poubelle à couvercle basculant, 5 litres
> Seite 158 / page 158

NEW

DESIGNWELT
J'adore

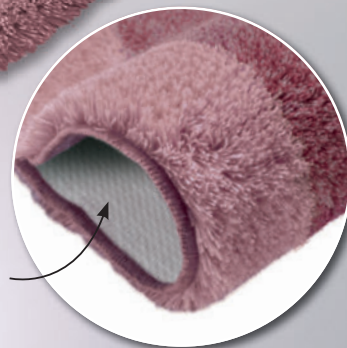

Mit rutschhemmender TPE-Beschichtung
Equipped with an anti-slip TPE-coating
Avec revêtement TPE antidérapant

100% Polyacryl



Florhöhe (mm)
Pile height
Hauteur mèches

20

Deckelbezug (mm)
Lid cover
Housse

20



436
Beere
*436 Beere



783
Mare
*754 Iceblue



8888 ... 104*
ca. 47 x 50 cm



9133 ... 135
ca. 60 x 60 cm



9133 ... 290
ca. 80 x 80 cm

Das passt dazu:
That fits: / Çı correspond:

ECLIPSE
Accessoire-Serie mit
gummierter Oberfläche
With rubberized surface
Avec surface caoutchoutée
> Seite 131 / page 131



JULIE



Mit rutschhemmender TPE-Beschichtung
 Equipped with an anti-slip TPE-coating
 Avec revêtement TPE antidérapant

100% Polyacryl



Florhöhe (mm)
 Pile height
 Hauteur mèches

20

Deckelbezug (mm)
 Lid cover
 Housse

20



270
 Bahamabeige



468
 Granat
 *453 Rubin

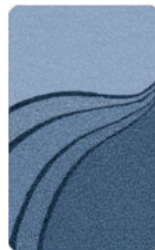

783
 Mare
 *754 Iceblue



901
 Anthrazit
 *901 Anthrazit



8888 ... 104*
 ca. 47 x 50 cm



9129 ... 539
 ca. 55 x 65 cm



9129 ... 360
 ca. 60 x 100 cm



9129 ... 225
 ca. 70 x 120 cm

NEW

DESIGNWELT
J'adore

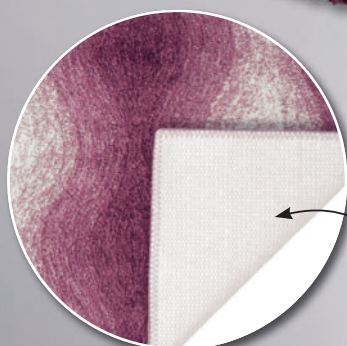

Mit rutschhemmender TPE-Beschichtung
Equipped with an anti-slip TPE-coating
Avec revêtement TPE antidérapant

100% Polyester



Florhöhe (mm)
Pile height
Hauteur mèches

19

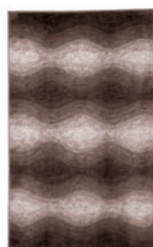

301
Nussbraun

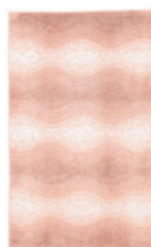

398
Pearl

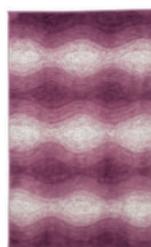

436
Beere

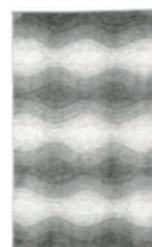

901
Anthrazit



9138 ... 539
ca. 55 x 65 cm

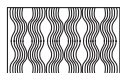

9138 ... 360
ca. 60 x 100 cm

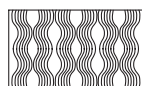

9138 ... 225
ca. 70 x 120 cm

LOUNGE



Mit rutschhemmender Beschichtung
 Equipped with an anti-slip coating
 Avec revêtement TPE antidérapant

75% Polyester + 25% Cotton



Florhöhe (mm)
 Pile height
 Hauteur mèches

23



271
 Taupe

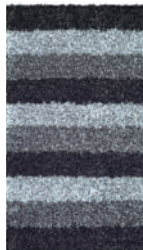

905
 Schiefer

Das passt dazu:
 That fits: / Ça correspond:

GLOSSY
 Schwingdeckeleimer in
 vielen Farben, 5 Liter
 Swing bin, 5 litres
 Poubelle à couvercle
 basculant, 5 litres
 > Seite 160 / page 160



4000 ... 135
 ca. 60 x 60 cm



4000 ... 360
 ca. 60 x 100 cm



4000 ... 225
 ca. 70 x 120 cm

NEW

DESIGNWELT
Magical Moments

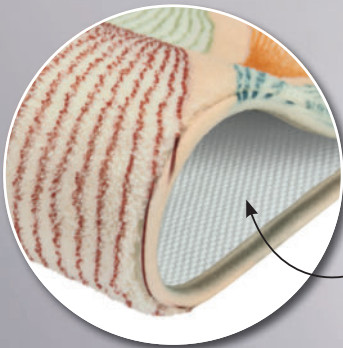

Mit rutschhemmender TPE-Beschichtung
Equipped with an anti-slip TPE-coating
Avec revêtement TPE antidérapant

Das passt dazu:
That fits: / Ça correspond:



MAGIC
Textiler Duschvorhang
im passenden Design
Textile shower curtain
in matching design
Rideau de douche en textile
au design assorti
> Seite 209 / page 209

NEW



BELLY
Accessoire-Serie
mit abnehmbaren
Silikonfuß
Removable silicone base
Pied en silicone amovible
> Seite 123 / page 123

100% Polyester



Florhöhe (mm)
Pile height
Hauteur mèches

15



148
Multicolor



9140 ... 433
ca. 50 x 60 cm



9140 ... 519
ca. 60 x 90 cm

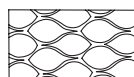

9140 ... 225
ca. 70 x 120 cm



DESIGNWELT
J'adore

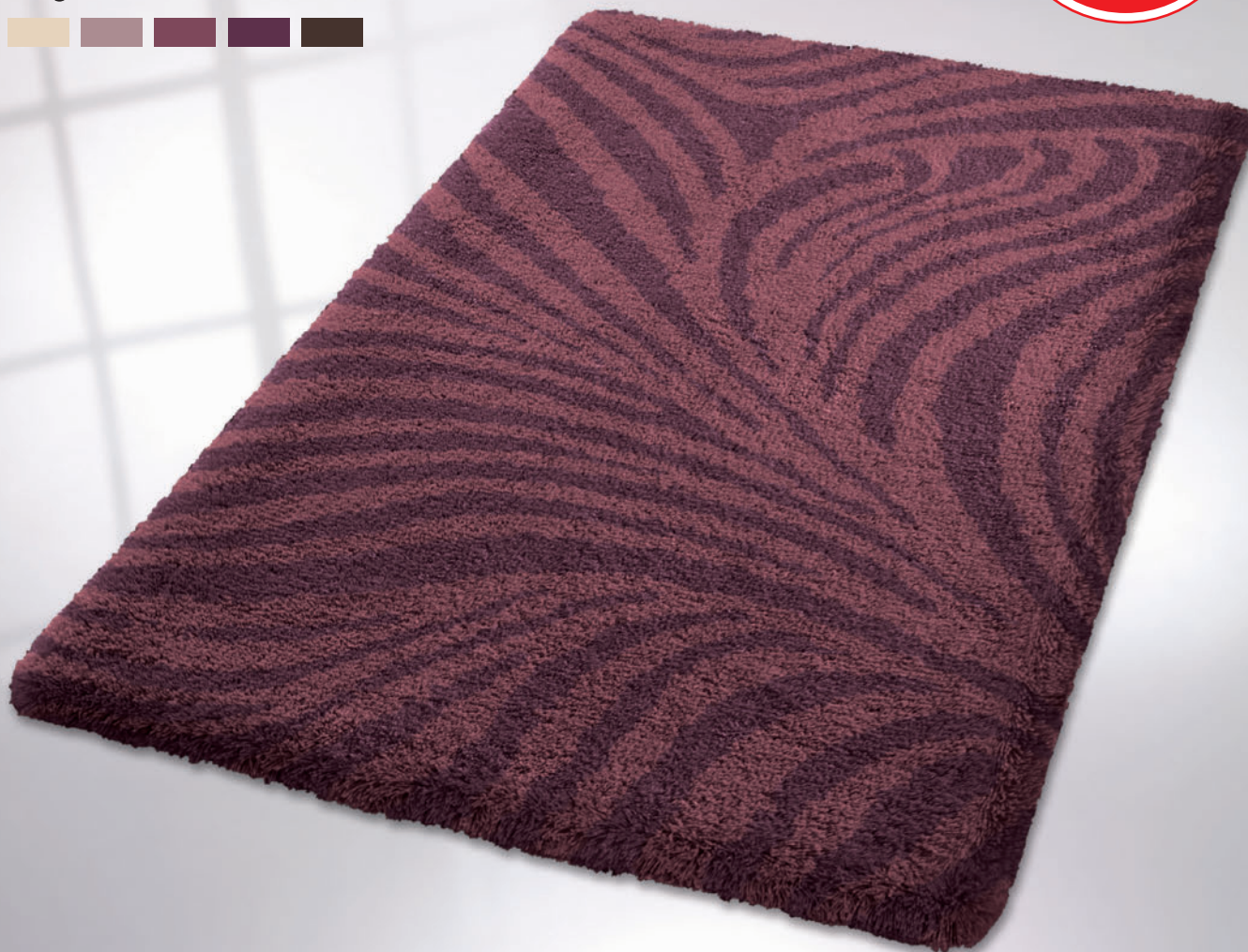

Mit rutschhemmender Beschichtung
Equipped with an anti-slip coating
Avec revêtement TPE antidérapant



100% Polyacryl



Florhöhe (mm)

Pile height
Hauteur mèches

15

Deckelbezug (mm)

Lid cover
Housse

20



8888 ... 104*
ca. 47 x 50 cm



9134 ... 539
ca. 55 x 65 cm

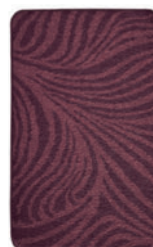

436
Beere
*436 Beere



9134 ... 360
ca. 60 x 100 cm

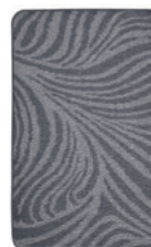

901
Anthrazit
*901 Anthrazit



9134 ... 225
ca. 70 x 120 cm

NEW



100% Polyacryl



Florhöhe (mm)

Pile height
Hauteur mèches

20

Deckelbezug (mm)

Lid cover
Housse

20



468
Granat
*453 Rubin



672
Türkis
*675 Petrol



754
Iceblue
*754 Iceblue

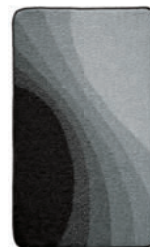

905
Schiefer
*901 Anthrazit



8888 ... 104*
ca. 47 x 50 cm



9144 ... 130
ca. 55 x 50 cm



9144 ... 539
ca. 55 x 65 cm

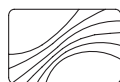

9144 ... 519
ca. 60 x 90 cm

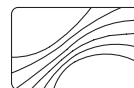

9144 ... 225
ca. 70 x 120 cm

MANDALA

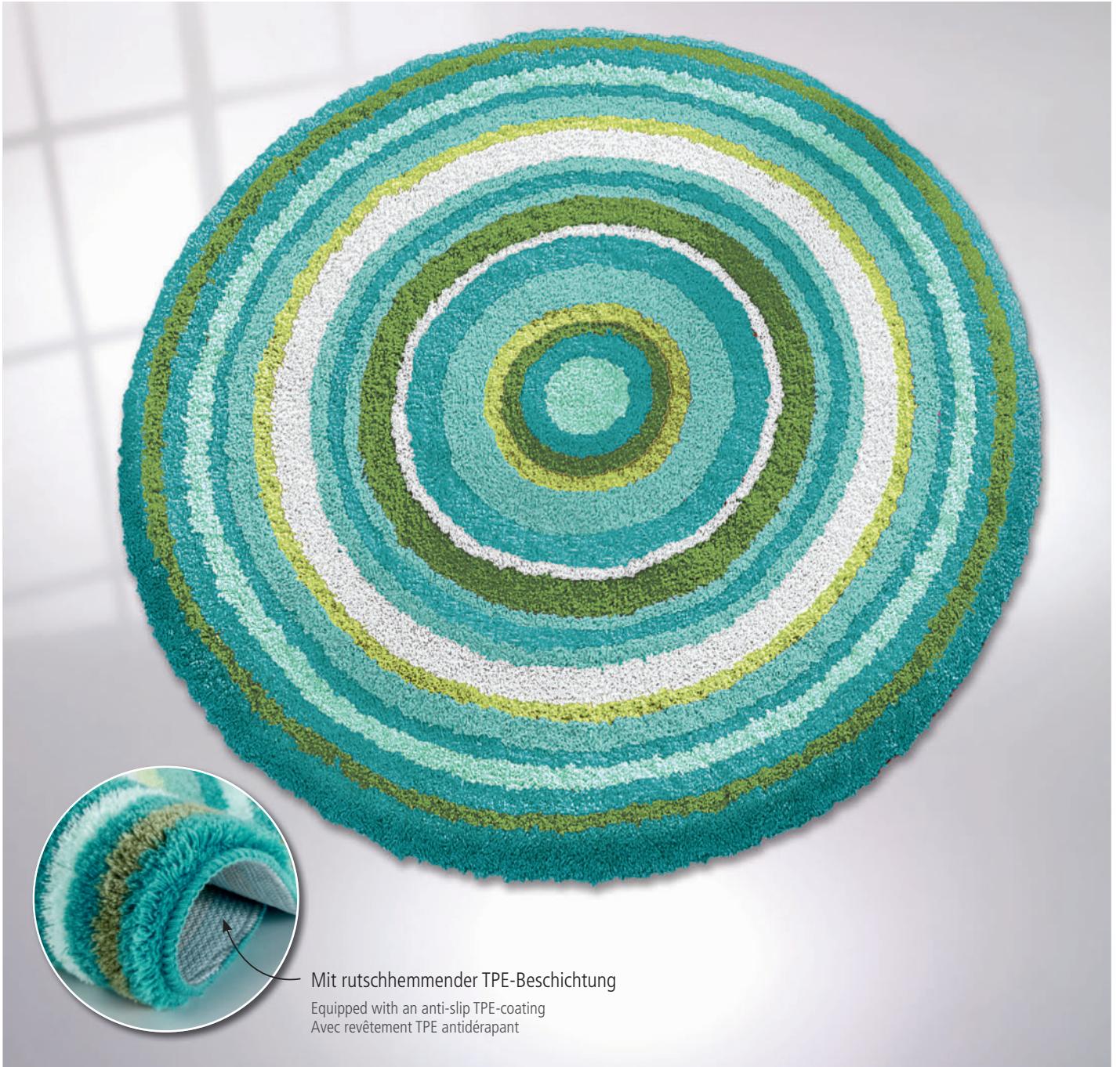

Mit rutschhemmender TPE-Beschichtung

Equipped with an anti-slip TPE-coating
Avec revêtement TPE antidérapant

100% Polyacryl



Florhöhe (mm)
Pile height
Hauteur mèches

20

Deckelbezug (mm)
Lid cover
Housse

20

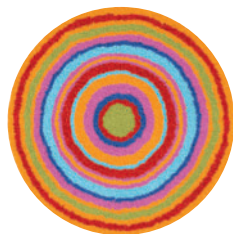

148
Multicolor
*453 Rubin

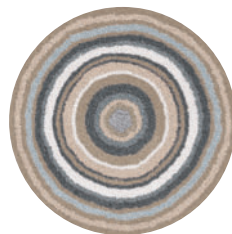

271
Taupe
*271 Taupe

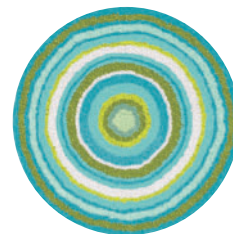

672
Türkis
*114 Schneeweiß



8888 ... 104*
ca. 47 x 50 cm



9105 ... 307
ca. 60 cm rund



9105 ... 518
ca. 80 cm rund



9105 ... 521
ca. 100 cm rund



Neue Farbe
New colour
Nouvelle couleur

Mit rutschhemmender TPE-Beschichtung
Equipped with an anti-slip TPE-coating
Avec revêtement TPE antidérapant

100% Polyester



Florhöhe (mm)
Pile height
Hauteur mèches

30



100
Weiß

146
Silbergrau

327
Marsala

649
Opal

698
Eucalyptus

783
Mare

905
Schiefer



9116 ... 150
ca. 50 x 50 cm



9116 ... 433
ca. 50 x 60 cm



9116 ... 519
ca. 60 x 90 cm



9116 ... 225
ca. 70 x 120 cm



9116 ... 657
ca. 80 x 140 cm



100% Polyacryl



Florhöhe (mm)

Pile height
Hauteur mèches

15

Deckelbezug (mm)

Lid cover
Housse

20

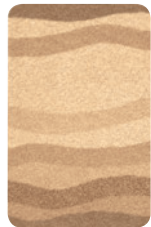

215
Naturbeige
* 224 Toffee

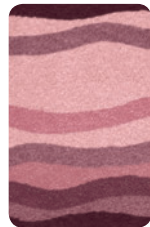

436
Beere
* 436 Beere

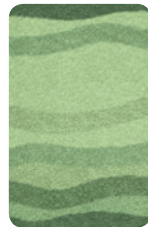

633
Minze
* 619 Linde



791
Himmelblau
* 799 Royalblau

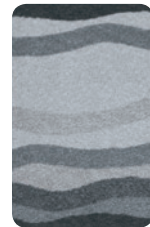

905
Schiefer
* 901 Anthrazit



8888 ... 104
ca. 47 x 50 cm



5510 ... 150
ca. 50 x 50 cm



5510 ... 433
ca. 50 x 60 cm



5510 ... 556
ca. 60 x 90 cm



5510 ... 427
ca. 65 x 115 cm



Mit rutschhemmender TPE-Beschichtung
 Equipped with an anti-slip TPE-coating
 Avec revêtement TPE antidérapant

100% Polyacryl



Florhöhe (mm)
 Pile height
 Hauteur mèches

20

Deckelbezug (mm)
 Lid cover
 Housse

20



8888 ... 104*
 ca. 47 x 50 cm



9107 ... 331
 ca. 55 x 65 cm

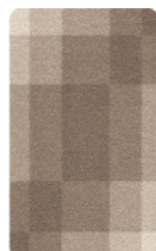

271
 Taupe
 *271 Taupe



333
 Brandy
 *539 Safran



615
 Kiwigrün
 *619 Linde



769
 Marineblau
 *769 Marineblau

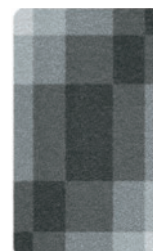

905
 Schiefer
 *901 Anthrazit

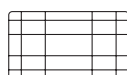

9107 ... 360
 ca. 60 x 100 cm



9107 ... 311
 ca. 70 x 120 cm

MONROVIA



Badteppich im Streifendesign
und Hoch-/Tiefoptik

With high/low optics
Avec une optique
haute/basse

Mit rutschhemmender TPE-Beschichtung

Equipped with an anti-slip TPE-coating
Avec revêtement TPE antidérapant

100% Polyester



Florhöhe (mm)
Pile height
Hauteur mèches

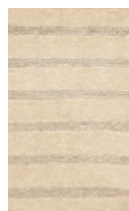

226
Sandbeige

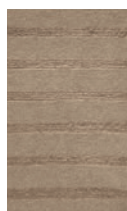

287
Kaschmir

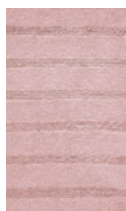

407
Old Rose

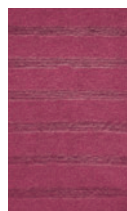

452
Burgund



685
Maledivia

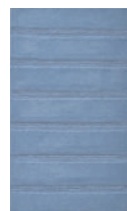

746
Stahlblau



977
Platin



4094 ... 135
ca. 60 x 60 cm



4094 ... 360
ca. 60 x 100 cm



4094 ... 225
ca. 70 x 120 cm



4094 ... 657
ca. 80 x 140 cm

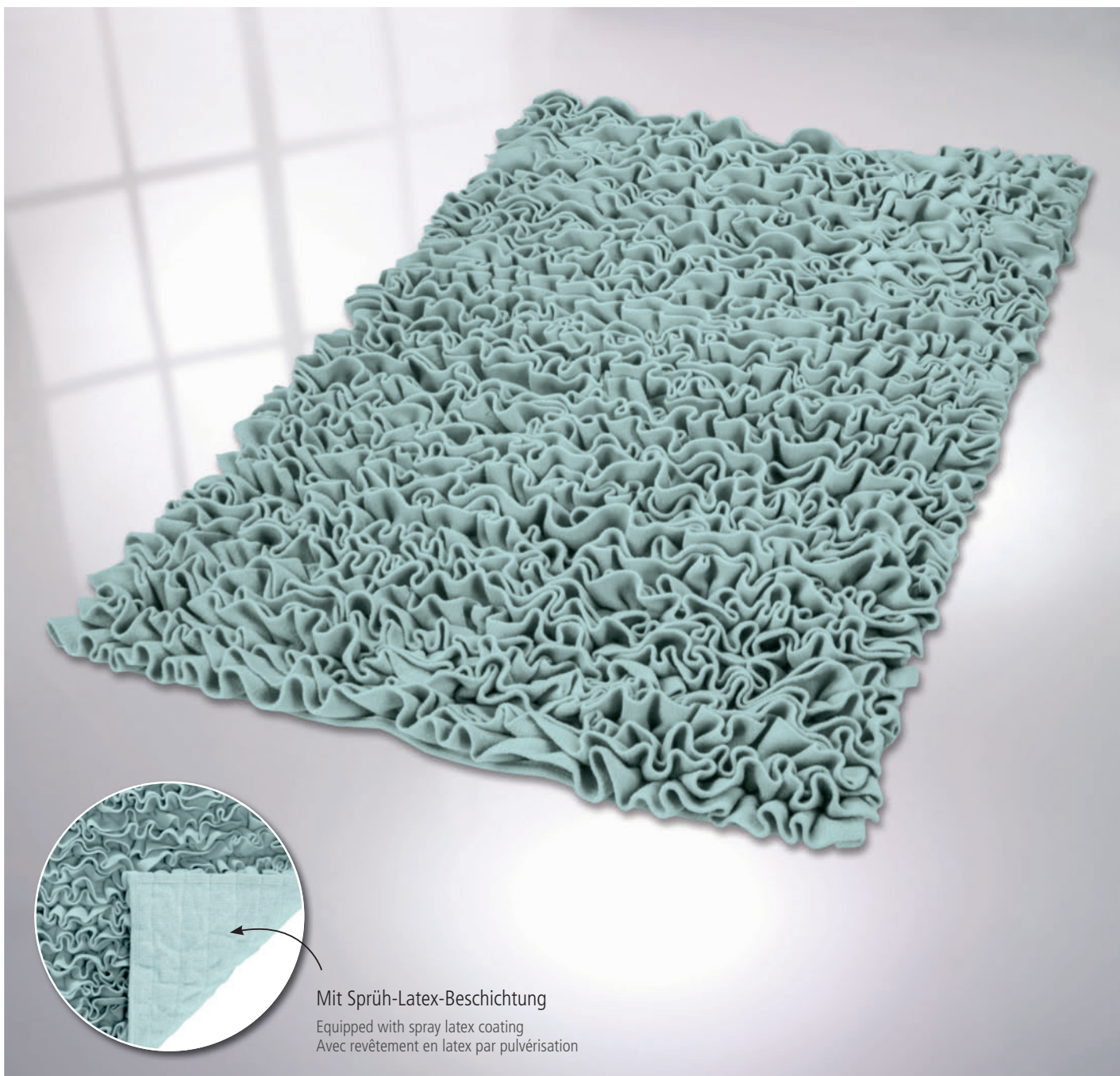

Mit Sprüh-Latex-Beschichtung
 Equipped with spray latex coating
 Avec revêtement en latex par pulvérisation

65% Polyester + 35% Cotton



Florhöhe (mm)
 Pile height
 Hauteur mèches

45



407
Old Rose

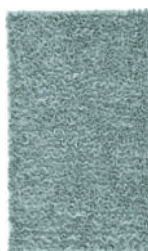

685
Maledivia



9127 ... 135
ca. 60 x 60 cm



9127 ... 360
ca. 60 x 100 cm



9127 ... 225
ca. 70 x 120 cm

Das passt dazu:
 That fits: / Ça correspond:

SAHARA
 Accessoire-Serie in
 passender Farbe
 Accessory series in
 matching color
 Série d'accessoires en
 couleur assortie
 > Seite 148 / page 148



OSLO



Mit rutschhemmender Beschichtung
 Equipped with an anti-slip coating
 Avec revêtement antidérapant

100% Polyester



Florhöhe (mm)
 Pile height
 Hauteur mèches

30



311
 Mahagoni

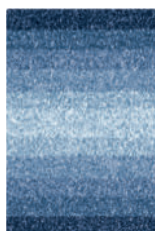

783
 Mare



977
 Platin



4077 ... 135
 ca. 60 x 60 cm



4077 ... 519
 ca. 60 x 90 cm



4077 ... 225
 ca. 70 x 120 cm



Mit rutschhemmender Beschichtung
 Equipped with an anti-slip coating
 Avec revêtement antidérapant

75% Polyester + 25% Polyacryl



Florhöhe (mm)
 Pile height
 Hauteur mèches



146
 Silbergrau



5471 ... 135
 ca. 60 x 60 cm



5471 ... 360
 ca. 60 x 100 cm



5471 ... 225
 ca. 70 x 120 cm

Das passt dazu:

That fits: / Ça correspond:

ROYAL
 Als Gästetuch, Handtuch
 oder Duschtuch.

Guest towel, hand towel
 or bath towel.
 Serviette invités, serviette de
 toilette ou serviette de bain.

> Seite 115 / page 115



RUMBA



Mit rutschhemmender TPE-Beschichtung

Equipped with an anti-slip TPE-coating
Avec revêtement TPE antidérapant

MICROFASER

100% Polyester / Microfaser



Florhöhe (mm)
Pile height
Hauteur mèches

25

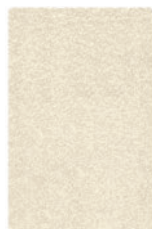

202
Natur



901
Anthrazit



5502 ... 256
ca. 65 x 50 cm



5502 ... 360
ca. 60 x 100 cm



5502 ... 225
ca. 70 x 120 cm



100% Polyester



Florhöhe (mm)
Pile height
Hauteur mèches

25

Mit rutschhemmender Beschichtung

Equipped with an anti-slip coating
Avec revêtement antidérapant



4071 ... 130
ca. 55 x 50 cm



4071 ... 539
ca. 55 x 65 cm



4071 ... 519
ca. 60 x 90 cm

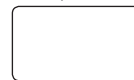

4071 ... 225
ca. 70 x 120 cm



4071 ... 657
ca. 80 x 140 cm

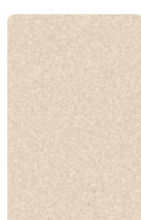

202
Natur



271
Taupe

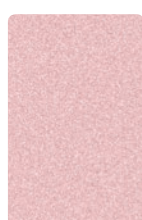

401
Nelke



468
Granat



615
Kiwigrün

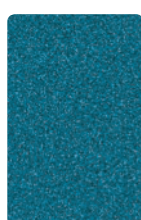

663
Pazifik



754
Iceblue



905
Schiefer



913
Nebel

SEAWORLD

Badteppich mit
maritimen Motiven
Bath rug with maritime motifs
Tapis de bain aux motifs maritimes

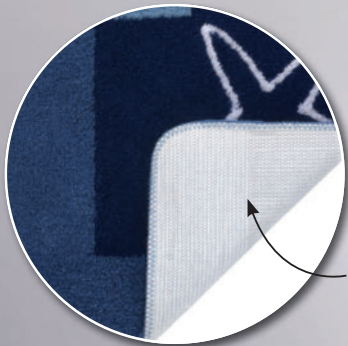

Mit rutschhemmender TPE-Beschichtung
Equipped with an anti-slip TPE-coating
Avec revêtement TPE antidérapant

100% Polyacryl



Florhöhe (mm)
Pile height
Hauteur mèches

20

Deckelbezug (mm)
Lid cover
Housse

20



769
Marineblau
*769 Marineblau



8888 ... 104
ca. 47 x 50 cm



5515 ... 256
ca. 50 x 65 cm



5515 ... 360
ca. 60 x 100 cm

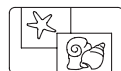

5515 ... 225
ca. 70 x 120 cm

Das passt dazu:
That fits: / Ça correspond:



MUSCHEL
Dekomotive mit Saugnäpfen

Dekomotive with suction cups
Décomotive à ventouses
> Seite 253 / page 253

Badteppich im Farbverlauf mit Hoch-/Tiefoptik

Bathroom rug featuring a colour gradient with high/low optic
Tapis de bain avec dégradé de couleurs et effet de relief/profondeur

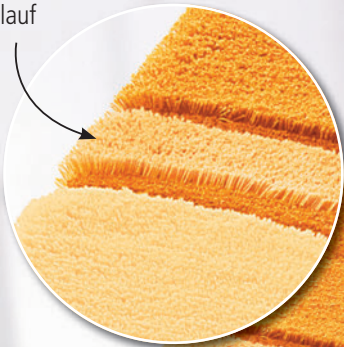

100% Polyacryl



Florhöhe (mm)
Pile height
Hauteur mèches



Deckelbezug (mm)
Lid cover
Housse



231
Bambusbeige
*224 Toffee



451
Weinrot
*453 Rubin



539
Safran
*539 Safran



712
Sorr.-Azurblau
*769 Marineblau



901
Anthrazit
*901 Anthrazit



8888 ... 104*
ca. 47 x 50 cm



5476 ... 129
ca. 55 x 55 cm



5476 ... 539
ca. 55 x 65 cm



5476 ... 360
ca. 60 x 100 cm



5476 ... 225
ca. 70 x 120 cm



Mit rutschhemmender TPE-Beschichtung
 Equipped with an anti-slip TPE-coating
 Avec revêtement TPE antidérapant

100% Polyacryl



Florhöhe (mm)
 Pile height
 Hauteur mèches



977
 Platin

Das passt dazu:
 That fits: / Ça correspond:

NOVA
 Textiler Duschvorhang
 mit passendem
 Sternenmotiv

Textile shower curtain with
 matching star motif
 Rideau de douche en textile
 assorti motif de l'étoile
 > Seite 210 / page 210



4084 ... 135
 ca. 60 x 60 cm



4084 ... 519
 ca. 60 x 90 cm



4084 ... 225
 ca. 70 x 120 cm



Mit rutschhemmender TPE-Beschichtung
 Equipped with an anti-slip TPE-coating
 Avec revêtement TPE antidérapant

100% Polyacryl



Florhöhe (mm)
 Pile height
 Hauteur mèches

20

Deckelbezug (mm)
 Lid cover
 Housse

20



289
 Seide
 * 271 Taupe



913
 Nebel
 * 977 Platin



8888 ... 104
 ca. 47 x 50 cm



5518 ... 150
 ca. 50 x 50 cm



5518 ... 433
 ca. 50 x 60 cm



5518 ... 556
 ca. 60 x 90 cm



5518 ... 225
 ca. 70 x 120 cm

STELLA



Badteppich mit unterschiedlich hohen Noppen
 Bath rug with different high pimples
 Tapis de bain avec différents boutons élevés

100% Polyester



Florhöhe (mm)
 Pile height
 Hauteur mèches



146
 Silbergrau



226
 Sandbeige



431
 Rouge

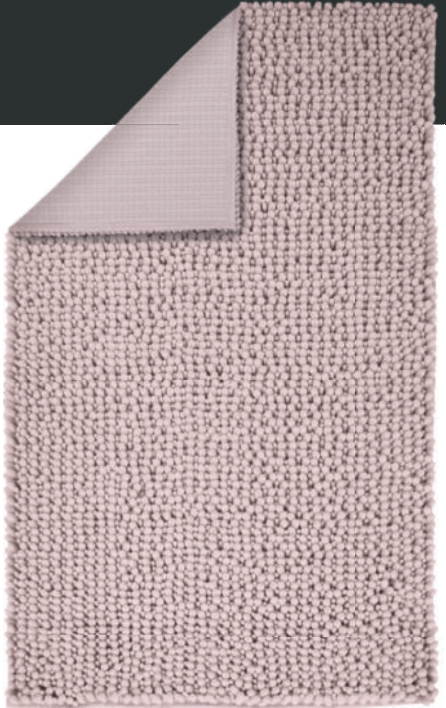

9142 ... 433
 ca. 50 x 60 cm



9142 ... 519
 ca. 60 x 90 cm

NEW



Mit rutschhemmender TPE-Beschichtung
 Equipped with an anti-slip TPE-coating
 Avec revêtement TPE antidérapant

100% Polyacryl



Florhöhe (mm)
 Pile height
 Hauteur mèches

20

Deckelbezug (mm)
 Lid cover
 Housse

20



287
 Kaschmir
 *271 Taupe



334
 Chili



675
 Petrol
 *675 Petrol



905
 Schiefer
 *901 Anthrazit



8888 ... 104*
 ca. 47 x 50 cm



9136 ... 130
 ca. 55 x 50 cm



9136 ... 539
 ca. 55 x 65 cm



9136 ... 360
 ca. 60 x 100 cm



9136 ... 225
 ca. 70 x 120 cm



9136 ... 657
 ca. 80 x 140 cm

TENDER

Weicher Badteppich mit diagonaler Streifenoptik in harmonischer Farbabstufung

Soft bathroom rug with diagonal striped look and harmonious colour grading
Tapis de bain doux avec effet de rayures en diagonale et dégradé de couleurs harmonieux

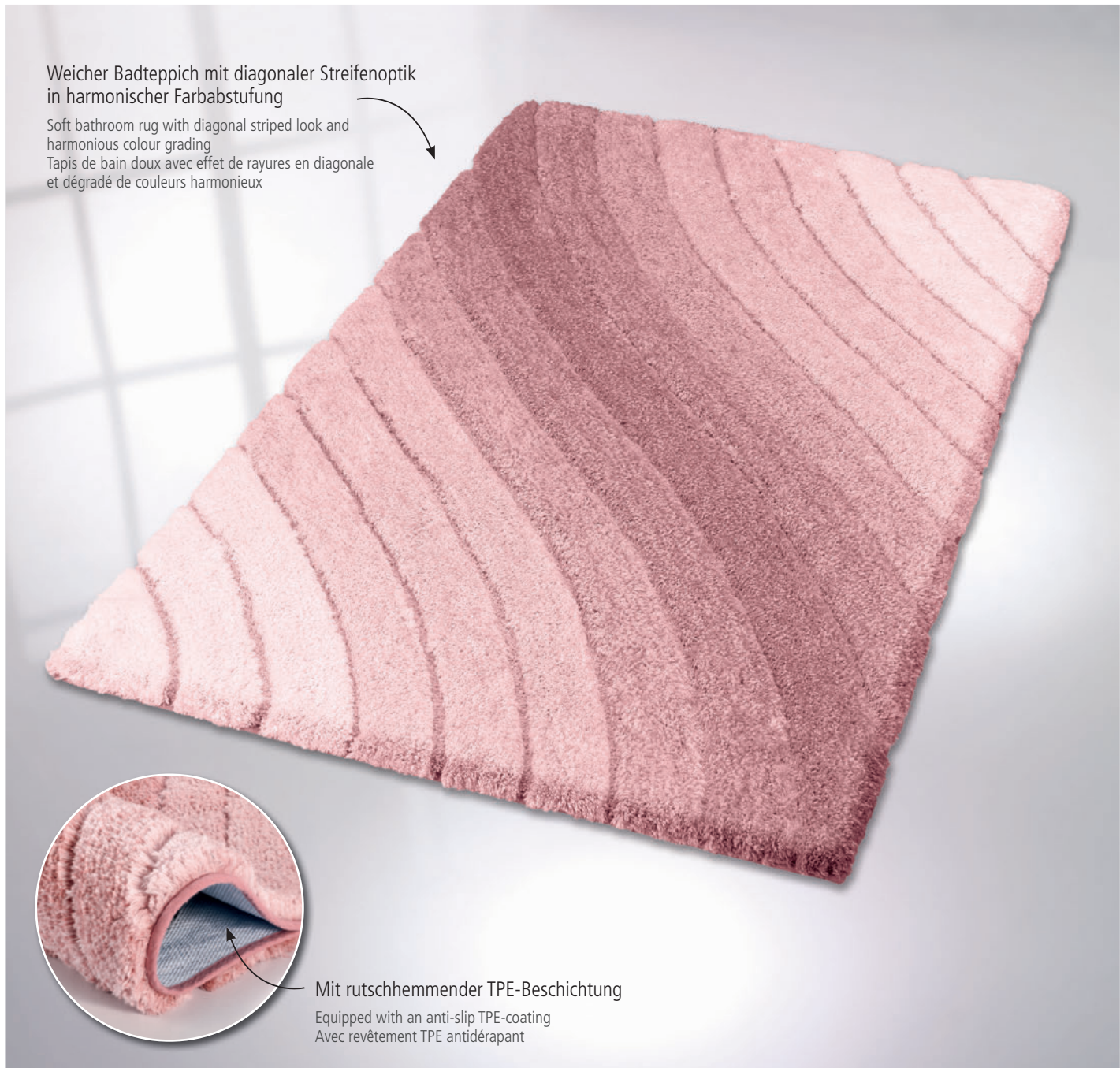

Mit rutschhemmender TPE-Beschichtung
Equipped with an anti-slip TPE-coating
Avec revêtement TPE antidérapant

100% Polyester



Florhöhe (mm)
Pile height
Hauteur mèches



226
Sandbeige

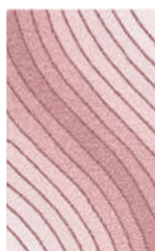

431
Rouge



649
Opal

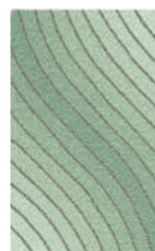

652
Schilf

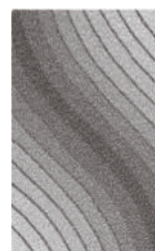

901
Anthrazit



4099 ... 135
ca. 60 x 60 cm

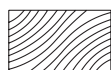

4099 ... 360
ca. 60 x 100 cm

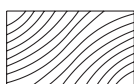

4099 ... 225
ca. 70 x 120 cm



DESIGNWELT
Framework



Mit rutschhemmender TPE-Beschichtung
Equipped with an anti-slip TPE-coating
Avec revêtement TPE antidérapant

100% Polyacryl



Florhöhe (mm)
Pile height
Hauteur mèches

20

Deckelbezug (mm)
Lid cover
Housse

20



115
Polarweiß
*114 Schneeweiß



926
Schwarz
*114 Schneeweiß



8888 ... 104*
ca. 47 x 50 cm



9135 ... 539
ca. 55 x 65 cm

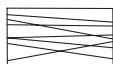

9135 ... 360
ca. 60 x 100 cm

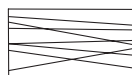

9135 ... 225
ca. 70 x 120 cm

Das passt dazu:
That fits: / Ça correspond:

SCANDIC CHAIR
Hocker mit 2in1
Funktion.

Stool with 2in1 function
Tabouret avec fonction 2en1
> Seite 165 / page 165





100% Polyacryl



Florhöhe (mm)

Pile height
Hauteur mèches

20

Deckelbezug (mm)

Lid cover
Housse

20



333
Brandy
* 316 Rost



689
Zeder
* 602 Klee



791
Himmelblau
* 799 Royalblau



8888 ... 104
ca. 47 x 50 cm



4588 ... 433
ca. 50 x 60 cm



4588 ... 556
ca. 60 x 90 cm

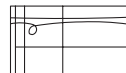

4588 ... 225
ca. 70 x 120 cm



Mit rutschhemmender TPE-Beschichtung
 Equipped with an anti-slip TPE-coating
 Avec revêtement TPE antidérapant

100% Polyester



Florhöhe (mm)
 Pile height
 Hauteur mèches

35



100
Weiß



158
Auster



220
Champagner



439
Rot



615
Kiwigrün



905
Schiefer



4035 ... 539
ca. 55 x 65 cm



4035 ... 556
ca. 60 x 90 cm



4035 ... 225
ca. 70 x 120 cm

Neue
Farben
New colours
Nouvelles
couleurs

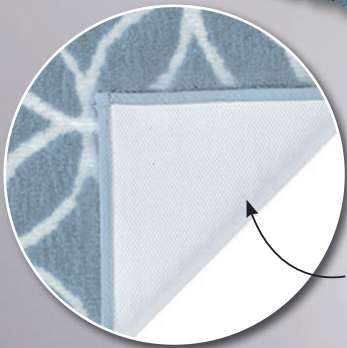

Mit rutschhemmender Beschichtung
Equipped with an anti-slip coating
Avec revêtement antidérapant

100% Polyester



Florhöhe (mm)
Pile height
Hauteur mèches



698
Eucalyptus



723
Azur



913
Nebel



9124 ... 433
ca. 50 x 60 cm



9124 ... 519
ca. 60 x 90 cm



9124 ... 225
ca. 70 x 120 cm

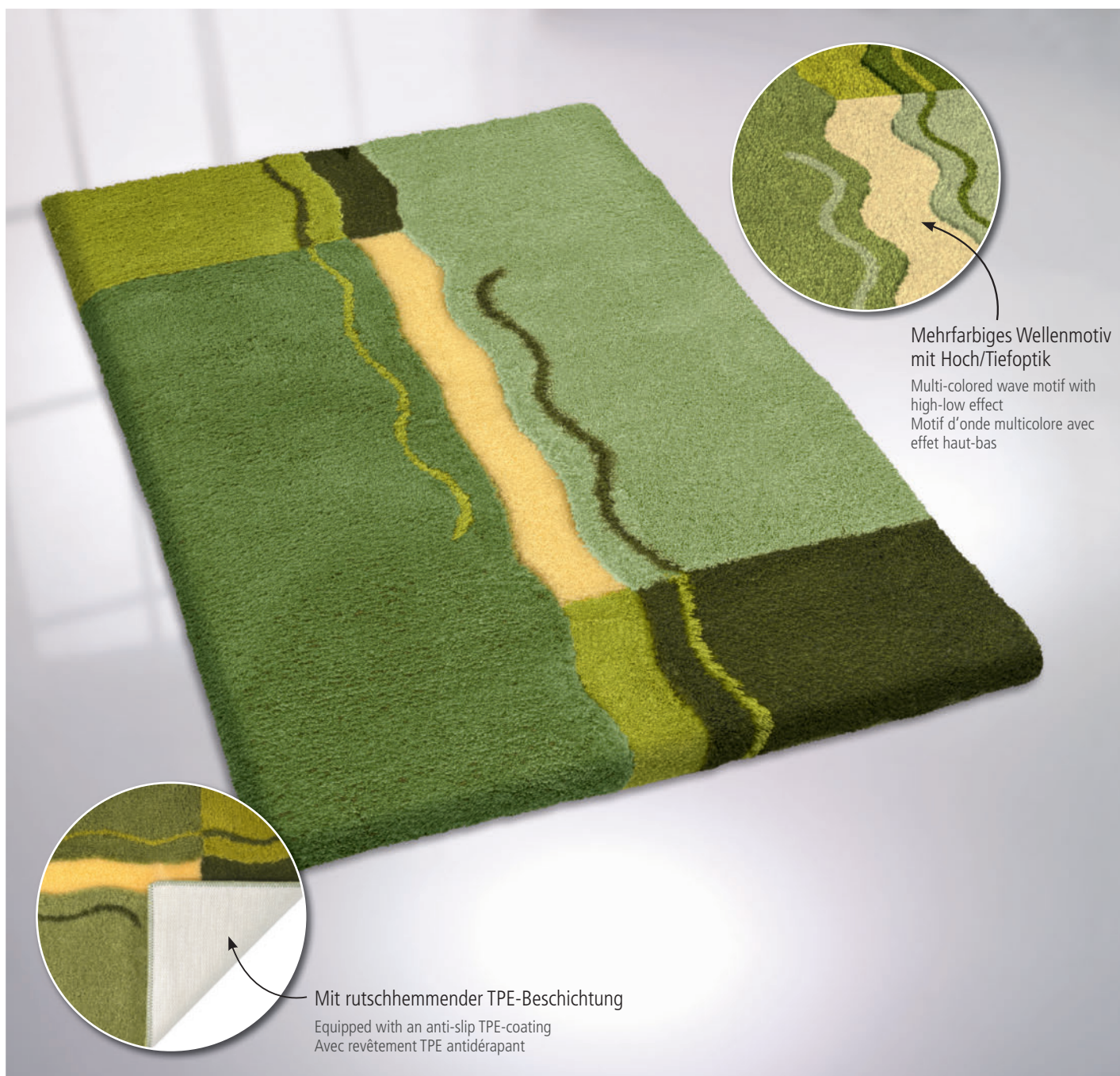

Mehrfarbiges Wellenmotiv mit Hoch/Tiefoptik

Multi-colored wave motif with high-low effect
Motif d'onde multicolore avec effet haut-bas

Mit rutschhemmender TPE-Beschichtung

Equipped with an anti-slip TPE-coating
Avec revêtement TPE antidérapant

100% Polyacryl



Florhöhe (mm)

Pile height
Hauteur mèches

15 23

Deckelbezug (mm)

Lid cover
Housse

20



225
Rehbraun
* 224 Toffee

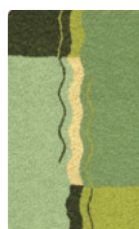

603
Palme
* 602 Klee

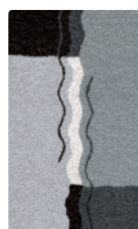

977
Platin
* 977 Platin



8888 ... 104
ca. 47 x 50 cm



5503 ... 129
ca. 55 x 55 cm



5503 ... 539
ca. 55 x 65 cm

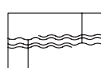

5503 ... 360
ca. 60 x 100 cm

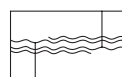

5503 ... 225
ca. 70 x 120 cm

Badteppich mit Hoch-/Tiefoptik
in geschwungenen harmonischen
Farbabstufungen

Bath rug with high-low effect and
curved color gradations
Tapis de bain avec effet haut-bas
et gradations de couleurs

Neue
Farbe
New colour
Nouvelle
couleur

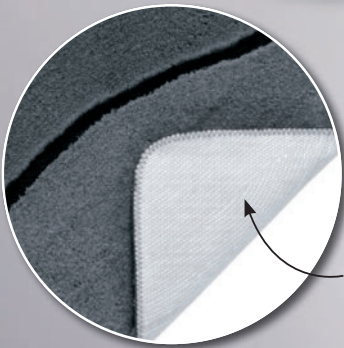

Mit rutschhemmender TPE-Beschichtung

Equipped with an anti-slip TPE-coating
Avec revêtement TPE antidérapant

100% Polyacryl



Florhöhe (mm)

Pile height
Hauteur mèches

15 23

Deckelbezug (mm)

Lid cover
Housse

20

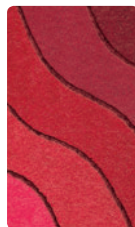

453
Rubin
* 453 Rubin



769
Marineblau
* 769 Marineblau

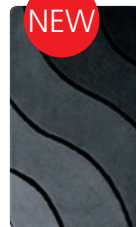

905
Schiefer
* 901 Anthrazit



8888 ... 104
ca. 47 x 50 cm



5507 ... 129
ca. 55 x 55 cm



5507 ... 539
ca. 55 x 65 cm



5507 ... 556
ca. 60 x 90 cm



5507 ... 225
ca. 70 x 120 cm

Neue
Farbe
New colour
Nouvelle
couleur



Mit rutschhemmender Beschichtung
Equipped with an anti-slip coating
Avec revêtement antidérapant

55% Polyester + 45% Cotton



Florhöhe (mm)
Pile height
Hauteur mèches

10



271
Taupe



407
Old Rose



742
Wasserblau



905
Schiefer

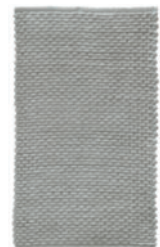

977
Platin



9109 ... 135
ca. 60 x 60 cm



9109 ... 360
ca. 60 x 100 cm



9109 ... 225
ca. 70 x 120 cm

Neue
Farben
New colours
Nouvelles
couleurs

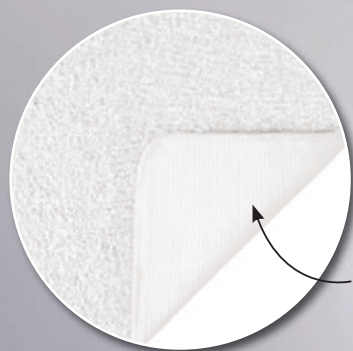

Mit rutschhemmender TPE-Beschichtung
Equipped with an anti-slip TPE-coating
Avec revêtement TPE antidérapant

100% Polyester



5527 ... 129
ca. 55 x 55 cm



5527 ... 433
ca. 50 x 60 cm



5527 ... 519
ca. 60 x 90 cm



5527 ... 225
ca. 70 x 120 cm

Florhöhe (mm)
Pile height
Hauteur mèches

18

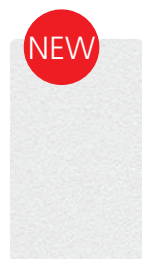

100
Weiß



146
Silbergrau

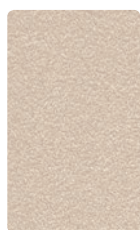

271
Taupe



453
Rubin

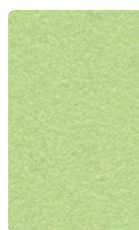

600
Grün

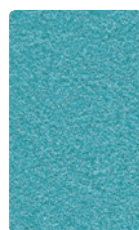

672
Türkis

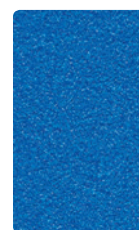

712
Sorr.-Azurblau



905
Schiefer

SOFT DECKEL

100% Polyacryl



Deckelbezug (mm)
Lid cover
Housse

20



8888 ... 104
ca. 47 x 50 cm



114
Schneeweiß



224
Toffee



271
Taupe



316
Rost



436
Beere



453
Rubin

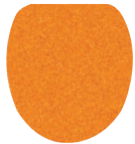

539
Safran



602
Klee



619
Linde



675
Petrol



754
Iceblue



769
Marineblau



799
Royalblau



901
Anthrazit



977
Platin

ANTI-RUTSCH

Teppichunterlage

Rutschhemmend auf allen glatten und harten Böden

Anti-slide carpet underlayer

To avoid carpet movements!

Support de tapis antidérapant

Ne glisse pas quelque soit la nature du sol, qu'il soit lisse ou dur!

100% Polyester



100
Weiß

5444 100 225
ca. 70 x 120 cm



Nachhaltig denken und ökologisch handeln

Sustainable thinking, ecological action
Réfléchir au durable et agir responsable

KOLLEKTION AUS NACHWACHSENDEN ROHSTOFFEN

COLLECTION MADE FROM SUSTAINABLE MATERIALS / UNE COLLECTION EN MATIÈRES RENOUVELABLES

In der heutigen Zeit sind Nachhaltigkeit und Umweltbewusstsein zentrales Thema unserer Gesellschaft. Mit unserem **ECO-LIVING-Sortiment** von Kleine Wolke erfüllen wir alle Anforderungen einer umweltbewussten Kollektion aus nachwachsenden Rohstoffen. Gesundheitsverträgliche Rohstoffe und biologisch abbaubare Fasern werden zu nachhaltigen Produkten gefertigt.

Sustainability and environmental awareness are central themes in today's society. With our ECO-LIVING product range from Kleine Wolke we are able to meet all the requirements of an environmentally conscious collection produced from renewable raw materials. We transform health-friendly raw materials and biodegradable fibres into sustainable products.

Aujourd'hui, la durabilité et la conscience écologique occupent une place centrale dans notre société. Avec notre assortiment ECO-LIVING Kleine Wolke, nous répondons à toutes les exigences requises pour une collection écologique en matières renouvelables. Pour fabriquer nos produits durables, nous utilisons des fibres biodégradables ainsi que des matières premières respectueuses de la santé.



BAUMWOLLE COTON / COTON

Baumwolle ist ein Naturprodukt und der Klassiker unter den Badteppichen mit vielen Vorteilen. Sie nimmt bis zu 20% Ihres Eigengewichtes an Feuchtigkeit auf ohne sich dabei nass anzufühlen. Sie ist hautsympathisch und strapazierfähig. Zudem ist die hochwertig gearbeitete Baumwolle atmungsaktiv und temperaturausgleichend.

Cotton is a natural product and a true bath rug classic that offers many benefits. It absorbs up to 20% of its own weight in moisture without feeling wet, it is durable and soft and kind to the skin. Plus, high-quality cotton is both breathable and temperature regulating.

Grand classique des tapis de bain, le coton est un produit naturel réunissant de nombreux atouts. Il absorbe jusqu'à 20 % de son poids en humidité, sans jamais produire cette sensation. Agréable au toucher, cette matière est également très résistante. Par ailleurs, ce coton de qualité est respirant et régule l'humidité.



BIO BAUMWOLLE ORGANIC COTON / COTON BIO

Das besondere beim biologischen Anbau von Baumwolle ist, dass auf den Einsatz von Pestiziden und Herbiziden verzichtet wird. Bio-Baumwolle, die aus organischem Anbau stammt, hat nur geringe Auswirkungen auf die Umwelt. Zudem ist der Wasserverbrauch niedriger als bei konventionellen Pflanzen. Bio-Baumwoll-Textilien enthalten keine Zusatzstoffe und sind besonders saugfähig und langlebig.

The special thing about organic cotton is that no pesticides or herbicides are used to help it grow. Organic cotton obtained from organic farming has a very low impact on the environment; its water consumption, for example, is lower than the conventional plant. Organic cotton textiles contain no additional substances and are exceptionally absorbent and long-lasting.

La culture biologique du coton est bien particulière, car elle renonce à l'emploi de pesticides et d'herbicides. Issu de la culture organique, le coton bio se démarque par son faible impact sur l'environnement. Par ailleurs la consommation d'eau est moins importante que celle des plantes habituelles travaillées. Les textiles à base de coton bio ne contiennent aucun additif et ils sont aussi particulièrement absorbants et durables.

BAMBUS BAMBOO / BAMBOU

Bambus – ein Naturprodukt aus nachwachsenden Rohstoffen. Bambus ist eine der am schnellsten wachsenden Pflanzen der Welt mit hartholzähnliche Eigenschaften, wodurch sich viele Vorteile ergeben. Die Holzmatten von Kleine Wolke sind sehr langlebig, antiallergisch und besonders hygienisch: Feuchtigkeit zieht nicht ein, sondern verdunstet schnell von der Oberfläche. Sie hinterlassen ein natürliches Ambiente in Ihrem Badezimmer.

Bamboo – a natural product from renewable raw materials. Bamboo is one of the fastest growing plants in the world with characteristics similar to those of hardwood. It is packed full of benefits. Wooden bath mats from Kleine Wolke are very durable, anti-allergic and extremely hygienic. The residual moisture isn't absorbed, but instead quickly evaporates from the surface. Bamboo will add a natural feel to your bathroom.

Le bambou : un produit naturel en matières premières renouvelables. Il fait partie des plantes à la croissance extra rapide, et possède des propriétés semblables à celles du bois, présentant donc de nombreux avantages. Les tapis en latte de bois Kleine Wolke sont ultra-durables, antiallergiques et particulièrement hygiéniques : l'humidité n'y pénètre pas, et s'évapore rapidement de la surface. Ces produits confèrent une ambiance unique à votre salle de bains.

KAUTSCHUK

100% Naturkautschuk – frisch gezapft bei Mutter Natur. Schutz in jeder Hinsicht bieten unsere Sicherheitseinlagen aus Naturkautschuk. Sicher nicht nur im Bad, sondern sicher auch für die Natur. Ein nachwachsender Rohstoff, der aus dem Milchsaft des Kautschukbaums gewonnen wird. Und dazu frei ist von umweltbelastenden Stoffen.

100% natural rubber – freshly tapped from mother nature. Our safety inserts made of natural rubber offer protection in every respect. They're not only safe in the bathroom, but also kind to nature. This renewable raw material, which is completely free of environmentally harmful substances, is extracted from the latex of the rubber tree.



Caoutchouc 100 % naturel : fraîchement collecté auprès de Mère Nature. Nos tapis de bain antidérapants en caoutchouc naturel offrent une protection à tous niveaux : ils sont non seulement sains dans votre salle de bains, mais aussi pour l'environnement. Une ressource renouvelable récoltée à partir du suc laiteux de l'arbre à caoutchouc, sans aucune substance polluante.



KOLLEKTION AUS RECYCELTEN MATERIALIEN

COLLECTION MADE FROM RECYCLED MATERIALS / UNE COLLECTION EN MATIÈRES RECYCLÉES



Unsere Badteppich Kollektion **ECO CARE** wird aus 100% recycelten Materialien hergestellt. Hierfür verwenden wir recycelte Baumwolle oder PET-Flaschen. Durch den geringen Energieverbrauch bei der Verarbeitung und dem Transport lassen sich erhebliche CO₂-Emissionen einsparen und Kleine Wolke trägt damit zum Klimaschutz bei. Durch nachhaltiges Recycling sehen wir uns in der Verantwortung Ressourcen nachhaltig zu nutzen, Energie einzusparen und die Umwelt zu schonen.

Our ECO CARE bath rug collection is made from recycled cotton or PET bottles – all 100% recycled materials. Low energy consumption during dismantling, processing and transport means that considerable CO₂ emissions can be saved, allowing Kleine Wolke to make a positive contribution to climate protection. We see ourselves as having a responsibility to use resources sustainably, save energy and protect the environment through sustainable recycling.

Notre collection de tapis de bain ECO CARE est 100 % fabriquée à partir de matières recyclées. À cet effet, nous utilisons du coton recyclé ou des bouteilles en PET. Grâce à la faible consommation d'énergie durant la culture, le traitement et le transport de nos produits, nous évitons d'importantes émissions de CO₂, et permettons à Kleine Wolke de contribuer à la protection climatique. En pratiquant le recyclage durable, notre entreprise est responsable d'utiliser durablement des ressources pour réaliser des économies d'énergie et préserver la planète.

RECYCLED PLASTIC

Kann aus PET-Flaschen ein Badteppich werden?

Kleine Wolke sagt „Ja“ und geht damit neue Wege. Die gewonnenen Fäden aus den PET-Flaschen werden in einem besonders energiesparenden Herstellungsverfahren hergestellt und für die Produktion unserer Badteppiche verwendet. Für ca. 1kg Garn benötigt man 38 PET Flaschen. Der hochwertig verarbeitete Polyester ist nicht nur ein sehr strapazierfähiges und langlebiges Material, es ist auch besonders saugfähig und hautfreundlich.

Can PET bottles be turned into a bath rug? Kleine Wolke says Yes! And we're breaking new ground in the process. The threads obtained from the PET bottles are produced in a particularly energy-saving manufacturing process and are used for the production of our bath rugs. Making approx. 1 kg of yarn requires 38 PET bottles. The high-quality polyester is not only extremely hard-wearing and durable, it's also extremely absorbent and kind to the skin.

Des bouteilles en PET peuvent-elles être transformées en tapis de bain ? Un grand « Oui » pour Kleine Wolke, qui explore de nouvelles perspectives. Les fils issus de bouteilles en PET sont obtenus lors d'un processus de fabrication particulièrement économe en ressources, puis utilisés pour la production de nos tapis de bain. 38 bouteilles en PET sont nécessaires pour fabriquer env. 1 kg de fil. Le polyester de qualité supérieure n'est pas seulement ultra-résistant et durable, mais il est aussi particulièrement absorbant et agréable au toucher.

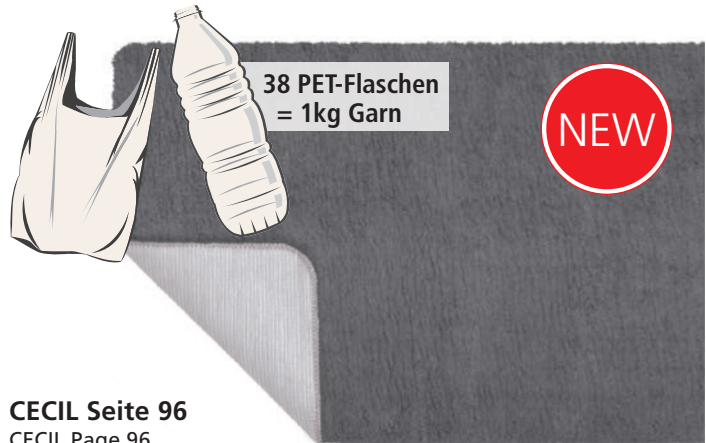

CECIL Seite 96
CECIL Page 96

RECYCLED COTTON

Aus Alt wird Neu! Bei der recycelten Baumwolle werden alte, anfallende Stoffreste zu neuen Garnen gesponnen und für die Herstellung des neuen Badteppichs **CHRISSEY** verwendet. Hierdurch können nicht nur nachhaltig Ressourcen geschont werden, die Herstellung ist auch besonders umweltschonend. Es handelt sich hierbei um ein mechanisches Recyclingverfahren, bei dem auf den Einsatz von chemischen Stoffen verzichtet wird. Die recycelte Baumwolle bietet viele Vorteile. Sie ist hautsympathisch, strapazierfähig, atmungsaktiv und temperaturregulierend.

Turning old into new! With recycled cotton, old fabric scraps are spun into new yarns which are then used to make the new **CHRISSEY** bath rug. This not only allows resources to be conserved in the long term, the manufacturing process is also exceptionally environmentally friendly. The process is a mechanical recycling process that does not use any chemicals. Recycled cotton has many benefits. It feels great against the skin, it's durable, breathable, and temperature regulating.

Du neuf avec de l'ancien ! Pour obtenir du coton recyclé, d'anciennes chutes de tissu sont transformées en nouveaux fils, utilisés pour fabriquer le nouveau tapis de bain **CHRISSEY**. Si cette technique permet de préserver des ressources durables, elle se révèle aussi particulièrement écologique. Il s'agit ici d'un processus de recyclage mécanique où l'on renonce à utiliser des substances chimiques. Le coton recyclé offre de nombreux avantages. Il est agréable à porter, résistant, respirant et régule la température.



CHRISSEY Seite 97
CECIL Page 97

Nachhaltig denken und ökologisch handeln!

ECO CARE

ECO LIVING

ARIZONA



- Überzeugend schlichtes Design
- Klassische Farbigkeit
- Doubleface-Optik

- Convincingly simple design
- Classic colours
- Reversible design

- Design simple et efficace
- Coloris classiques
- Aspect double face



Nachhaltig denken und ökologisch handeln!



Wende-Design
Reversible Design
Aspect double face

ECO CARE

100% Cotton



Florhöhe (mm)

Pile height
Hauteur mèches



146
Silbergrau



202
Natur

ECO LIVING



5477 ... 539
ca. 55 x 65 cm

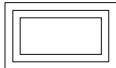

5477 ... 360
ca. 60 x 100 cm

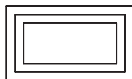

5477 ... 225
ca. 70 x 120 cm

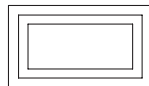

5477 ... 657
ca. 80 x 140 cm

- Modernes Rautenmotiv
- Dezentres Farbspiel
- Passende Frottierware

- Modern diamond motif
- Discreet play of colours
- Matching terry towelling

- Motif de diamant moderne
- Jeu de couleurs discret
- Serviettes éponge assorties



Nachhaltig denken und ökologisch handeln!

100% Cotton



Florhöhe (mm)
Pile height
Hauteur mèches

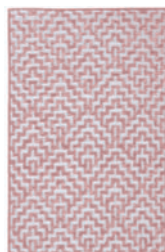

413
Pastellrose

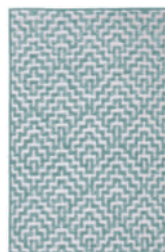

652
Schilf

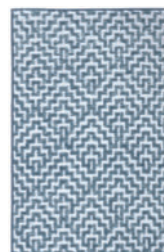

783
Mare

Das passt dazu:
That fits: / Ça correspond:



9125 ... 433
ca. 50 x 60 cm



9125 ... 519
ca. 60 x 90 cm

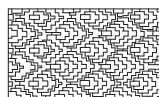

9125 ... 225
ca. 70 x 120 cm

BOTANY

Jacquardgewebte Handtücher mit Wendedesign

Jacquard Woven towels with reversible design
Serviettes tissées jacquard avec un design tournant

> Seite 113 / page 113

ECO CARE

ECO LIVING

CARACAS



Weicher Baumwoll/Viskose-
Teppich in angesagter
Vintageoptik

Stylish soft cotton/viscose
vintage-style rug

Tapis doux en coton et viscose
avec un aspect vintage tendance



Nachhaltig denken und ökologisch handeln!

ECO CARE

78% Cotton + 22% Viskose



Florhöhe (mm)
Pile height
Hauteur mèches

10



146
Silbergrau

Mit angesagter
Vintage-Optik
Vintage-style
Vintage tendance



ECO LIVING



4065 ... 135
ca. 60 x 60 cm



4065 ... 360
ca. 60 x 100 cm



4065 ... 225
ca. 70 x 120 cm

Hochwertiger Baumwoll-
Webteppich in modischem
Marmor-Design

High-quality cotton woven rug
in a stylish marble design

Tapis tissé de qualité en coton
dans un design marbre moderne



Das passt dazu:
That fits: / Ça correspond:

100% Cotton



Florhöhe (mm)
Pile height
Hauteur mèches

16

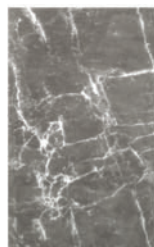

977
Platin

MARBLE
Textiler Duschvorhang in
Marmor-Optik

Textile shower curtain in
marble look
Rideau de douche textile
aspect marbre

> Seite 205 / page 205



MARMOR
Accessoire-Serie
aus Glas in
Marmor-Optik

Accessories series
of glass in marble look
Série d'accessoires
de verre en aspect marbré
> Seite 143 / page 143



4073 ... 135
ca. 60 x 60 cm



4073 ... 360
ca. 60 x 100 cm



4073 ... 225
ca. 70 x 120 cm

Nachhaltig denken und ökologisch handeln!

ECO CARE

ECO LIVING



**Recycled
Plastic**



Nachhaltig denken und ökologisch handeln!

ECO CARE

100% Polyester



Florhöhe (mm)
Pile height
Hauteur mèches

15



100
Weiβ



146
Silbergrau



901
Anthrazit



9145 ... 433
ca. 50 x 60 cm



9145 ... 519
ca. 60 x 90 cm



9145 ... 225
ca. 70 x 120 cm

Recycled Plastic

- Wiederverwendung wertvoller Rohstoffe
- Besonders energiesparendes Herstellungsverfahren
- 1 kg Garn aus ca. 38 PET-Flaschen
- Ressourcenschonende Herstellung

- Reuse of valuable raw materials
- Especially energy-saving production process
- 1 kg of yarn is obtained from approximately 38 PET bottles
- Resource-conserving production

- Réutilisation de ressources précieuses
- Technique de fabrication particulièrement économique
- 1 kg de fil est obtenu à partir d'env. 38 bouteilles en PET
- Fabrication respectueuse des ressources

ECO LIVING

NEW



Recycled Cotton



Wendeteppich aus 100% recycleter Baumwolle. Eine Seite mit geschnittenem Flor die andere Seite mit Schlingen gefertigt.

Reversible carpet made of 100% recycled cotton. One side with cut pile the other side with slings made.
Tapis réversible en coton 100% recyclé. Un côté avec une pile coupée, l'autre ôté avec les frondes sont faites.



Nachhaltig denken und ökologisch handeln!

100% Cotton



Florhöhe (mm)
Pile height
Hauteur mèches

10
10



100
Weiß



146
Silbergrau



901
Anthrazit

Recycled Cotton

- Wiederverwendung wertvoller Rohstoffe
- Umweltschonendes, mechanisches Recyclingverfahren ohne den Einsatz von chemischen Stoffen
- Hautsympathisch und strapazierfähig

- Reuse of valuable raw materials
- Environmentally friendly, mechanical recycling process without the use of chemical substances
- Skin-friendly and very hardwearing

- Réutilisation de ressources précieuses
- Processus de recyclage mécanique et écologique sans l'utilisation de substances chimiques
- Agréable au toucher et ultra durable



9146 ... 539
ca. 55 x 65 cm



9146 ... 360
ca. 60 x 100 cm



9146 ... 427
ca. 65 x 115 cm

ECO CARE

ECO LIVING

CORAL

Nachhaltig denken und ökologisch handeln!



Feiner Webteppich mit
aktuellem Korallendesign

Fine woven carpet with
current coral design

Tapis finement tissé avec
conception actuelle des coraux



ECO CARE

85% Cotton + 15% Viskose



Florhöhe (mm)
Pile height
Hauteur mèches

10



411
Hummer

Das passt dazu:
That fits: / Ça correspond:

PUR SHINY
Accessoire-Serie in schlanker Form
und neuer, passender Farbe.

Accessory series in slim form and
new matching color.
Série d'accessoires sveltes avec
nouvelle couleur assortie.
> Seite 147 / page 147



ECO LIVING



9126 ... 135
ca. 60 x 60 cm



9126 ... 360
ca. 60 x 100 cm



9126 ... 225
ca. 70 x 120 cm

NEW

2-teiliges Badteppich-Set
mit Noppenoptik

2-piece bath rug set
with knobbed look

Set de 2 tapis de bain
à picots



Nachhaltig denken und ökologisch handeln!

100% Cotton



Florhöhe (mm)
Pile height
Hauteur mèches

6



202
Natur

Das passt dazu:
That fits: / Ça correspond:

NEW

DOTTY
Accessoire-Serie mit feiner
Pünktchen-Struktur
With fine dot structure
Avec une structure à picots.
> Seite 129 / page 129

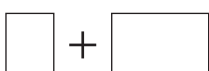

5536 ... 907
ca. 50 x 40 cm + 50 x 80 cm

ECO CARE

ECO LIVING

EVERGLADES



Elegant hochwertiger Webteppich
in glanzvoller Viskose/Baumwoll-
optik

Elegant top-quality woven
rug in brilliant viscose /
cottonlook

Élégant tapis tissé, de qualité-
supérieure, en viscose brillante /
aspect coton



Nachhaltig denken und ökologisch handeln!

ECO CARE

67% Cotton + 33% Viskose



Florhöhe (mm)
Pile height
Hauteur mèches

10

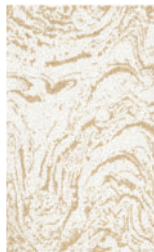

202
Natur

Glanzvolle Viskose-
Baumwolloptik
Brilliant viscose/cotton
look
En viscose brillante/
aspect coton

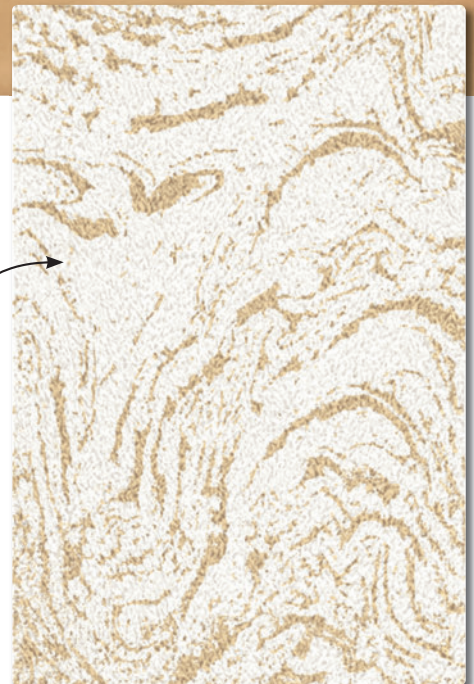

ECO LIVING



4091 ... 135
ca. 60 x 60 cm



4091 ... 519
ca. 60 x 90 cm



4091 ... 225
ca. 70 x 120 cm

- Premium Produkt
- Langstaplige Baumwolle mit hohem Gewicht
- Doubleface - Optik

- Luxury product
- Deep pile heavyweight cotton
- Reversible design

- Produit de première qualité
- Coton longue fibre au poids élevé
- Aspect double face



Nachhaltig denken und ökologisch handeln!

100% Cotton



Florhöhe (mm)
Pile height
Hauteur mèches



114
Schneeweiß



146
Silbergrau



202
Natur



905
Schiefer



5418 ... 539
ca. 55 x 65 cm

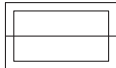

5418 ... 360
ca. 60 x 100 cm

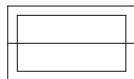

5418 ... 225
ca. 70 x 120 cm

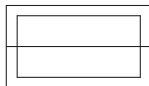

5418 ... 453
ca. 85 x 150 cm

ECO CARE

ECO LIVING

KANSAS



- Frische Farbigkeit
- Junge, modische Uni-Optik
- Rutschhemmende Rückenbeschichtung

- Fresh colours
- Young, fashionable plain design
- Non-slip backing

- Coloris frais
- Aspect uni, jeune et tendance
- Revêtement antidérapant

Neue
Farben
New colours
Nouvelles
couleurs



Nachhaltig denken und ökologisch handeln!

ECO CARE

100% Cotton



Florhöhe (mm)
Pile height
Hauteur mèches

16

ECO LIVING

100 Weiß	202 Natur	352 Kastanie	401 Nelke	452 Burgund	488 Orange
606 Olivgrün	645 Grün	672 Türkis	723 Azur	791 Himmelblau	905 Schiefer



4018 ... 539
ca. 55 x 65 cm



4018 ... 519
ca. 60 x 90 cm



4018 ... 225
ca. 70 x 120 cm



4018 ... 657
ca. 80 x 140 cm

NEW

Badteppich mit Blättermotiv
aus 100% Baumwolle

Bath rug with leaf motif
made of 100% cotton

Tapis de bain à
motif de feuilles



DESIGNWELT
Green Infusion

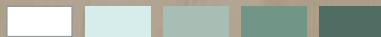

Das passt dazu:
That fits: / Ça correspond:



NEW

LEAF
Textiler Duschvorhang
im passenden Design
Textile shower curtain in
matching design
Rideau de douche en textile
au design assorti
> Seite 208 / page 208

100% Cotton



Florhöhe (mm)
Pile height
Hauteur mèches

10



685
Maledivia



901
Anthrazit



9137 ... 433
ca. 50 x 60 cm



9137 ... 519
ca. 60 x 90 cm

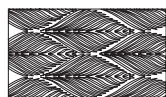

9137 ... 225
ca. 70 x 120 cm

LEAF
Accessoire-Serie
im zweifarbigen
Blättermotiv
With two-coloured
leaf motif
Avec un motif de feuille
bicolore
> Seite 139 / page 139

NEW



Nachhaltig denken und ökologisch handeln!

ECO CARE

ECO LIVING

Nachhaltig denken und ökologisch handeln!



- Frische Farbigkeit
- Junge, modische Uni-Optik
- Rutschhemmende Rückenbeschichtung

- Fresh colours
- Young, fashionable plain design
- Non-slip backing

- Coloris frais
- Aspect uni, jeune et tendance
- Revêtement antidérapant



ECO CARE

100% Cotton



Florhöhe (mm)
Pile height
Hauteur mèches



202
Natur



901
Anthrazit

Das passt dazu:

That fits: / Ça correspond:



CUBIC

Zeitlose Accessoire-Serie aus Steinzeug in vielen Farben

Timeless accessory series of stoneware in many colors
Série d'accessoires intemporels en grès de nombreuses couleurs

> Seite 128 / page 128

ECO LIVING



5489 ... 539
ca. 55 x 65 cm

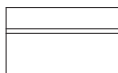

5489 ... 360
ca. 60 x 100 cm

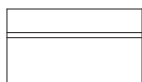

5489 ... 225
ca. 70 x 120 cm

- Weicher Flor
- Hochwertige Baumwolle
- Interessante 2-Farbigkeit
- Soft pile
- High quality wool
- Interesting dual colour scheme
- Fibres douces
- Coton de haute qualité
- Look bicolore attrayant



Nachhaltig denken und ökologisch handeln!

100% Cotton



Florhöhe (mm)
Pile height
Hauteur mèches

12

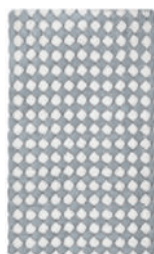

146
Silbergrau



271
Taupe



407
Old Rose

Das passt dazu:

That fits: / Ça correspond:

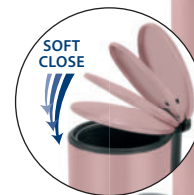

SILENCE

Treteimer mit SoftClose, 3 Liter

Pedal bin with SoftClose, content 3 litres
Poubelle à pédale avec SoftClose, contenu 3 litres

> Seite 161 / page 161



4036 ... 135
ca. 60 x 60 cm



4036 ... 360
ca. 60 x 100 cm

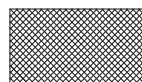

4036 ... 225
ca. 70 x 120 cm

ECO CARE

ECO LIVING

PHOENIX

Nachhaltig denken und ökologisch handeln!



- Weicher Flor
- Hochwertige Baumwolle
- 2 unterschiedliche Florhöhen

- Soft pile
- High quality wool
- 2 different pile heights

- Fibres douces
- Coton de haute qualité
- 2 hauteurs mèches différentes



Hoch-/Tiefeffekt durch weiße Streifen in niedriger Florhöhe
 High/low effect created by stripes at low pile height
 Effet de relief/profondeur grâce aux rayures et aux poils courts de l'article

ECO CARE

85% Cotton + 15% Polyester



Florhöhe (mm)
 Pile height
 Hauteur mèches



146
 Silbergrau



271
 Taupe

ECO LIVING



4045 ... 135
 ca. 60 x 60 cm



4045 ... 360
 ca. 60 x 100 cm



4045 ... 225
 ca. 70 x 120 cm

Das passt dazu:

That fits: / Ça correspond:

NOA

Gestreifter Duschvorhang
 aus 100% PEVA

Striped shower curtain made of 100% PEVA
 Rideau de douche rayé en 100% PEVA

> Seite 221 / page 221



NEU

- Strukturierter Baumwollteppich
- Nachhaltig erzeugte Baumwolle
- Abbaubare Fasern
- Structured cotton carpet
- Sustainably produced cotton
- Degradable fibres
- Tapis en coton structuré
- Le coton produit de manière durable
- Fibres dégradables



Nachhaltig denken und ökologisch handeln!

100% Cotton



Florhöhe (mm)
Pile height
Hauteur mèches

8
17



146
Silbergrau



202
Natur



271
Taupe



9147 ... 433
ca. 50 x 60 cm



9147 ... 519
ca. 60 x 90 cm

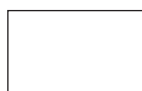

9147 ... 427
ca. 65 x 115 cm

ECO CARE

ECO LIVING

SARA



Jacquardgewebter Badteppich aus nachhaltig erzeugter Baumwolle

Jacquard woven bath rug from sustainably produced cotton

Tapis de bain tissé Jacquard à partir de coton produit de manière durable



Nachhaltig denken und ökologisch handeln!

ECO CARE

100% Cotton



Florhöhe (mm)

Pile height
Hauteur mèches

4



146
Silbergrau



202
Natur



Mit praktischer Metallöse zum Aufhängen

With practical metal eyelet for hanging up
Avec œillet métallique pratique pour un accrochage facile

ECO LIVING



9148 ... 207
ca. 50 x 80 cm

Eine neue Struktur in toniger
Melange aus geschnittenem Flor
und Schlingen

A new structure in tonal blends
made from dense cut pile and
loop pile

Une nouvelle structure chinée
ton sur ton, en fibres coupées
et boucles



Nachhaltig denken und ökologisch handeln!

100% Cotton



Florhöhe (mm)
Pile height
Hauteur mèches

10



407
Old Rose



652
Schiff

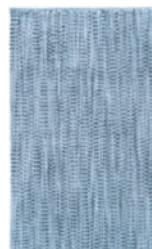

720
Blau



977
Platin



9108 ... 135
ca. 60 x 60 cm



9108 ... 360
ca. 60 x 100 cm



9108 ... 225
ca. 70 x 120 cm

ECO CARE

ECO LIVING

ZAGREB



Nachhaltig denken und ökologisch handeln!

ECO CARE

100% Cotton



Florhöhe (mm)
Pile height
Hauteur mèches

22



100
Weiß



617
Distel



791
Himmelblau



901
Anthrazit

ECO LIVING



5529 ... 433
ca. 50 x 60 cm



5529 ... 270
ca. 55 x 85 cm

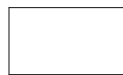

5529 ... 427
ca. 65 x 115 cm



Nachhaltig denken und ökologisch handeln!

100% Cotton



Gewicht: 800 g/qm
Weight: 800 g/qm
Poids: 800 g/qm

					
114 Schneeweiß	226 Sandbeige	327 Marsala	398 Pearl	443 Magnolie	452 Burgund
					
607 Salbeigrün	617 Distel	683 Smaragd	754 Iceblue	912 Dunkelgrau	926 Schwarz



3009 ... 207
ca. 50 x 80 cm

ECO CARE

ECO LIVING

BRIDGE FROTTIERVORLEGER



100% Cotton



Gewicht: 700 g/qm
Weight: 700 g/qm
Poids: 700 g/qm



100
Weiß

133
Basalt



723
Azur

912
Dunkelgrau

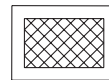

3016 ... 442
ca. 50 x 70 cm

Nachhaltig denken und ökologisch handeln!

ECO CARE

ECO LIVING

PLAZA FROTTIERVORLEGER



100% Cotton



Gewicht: 900 g/qm
Weight: 900 g/qm
Poids: 900 g/qm



114
Schneeweiß

208
Ecu

462
Rot



912
Dunkelgrau

926
Schwarz

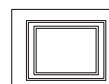

3006 ... 377
ca. 60 x 80 cm



100% Cotton



Gewicht: 500 g/qm

Weight: 500 g/qm
Poids: 500 g/qm



3021 ... 262

Handtuch

Hand Towel
Serviette de toilette

ca. 50 x 100 cm

3021 ... 226

Duschtuch

Bath Towel
Serviette de bain

ca. 70 x 140 cm

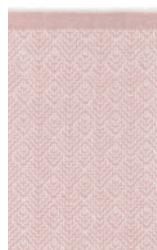

413
Pastellrose



652
Schilf



783
Mare

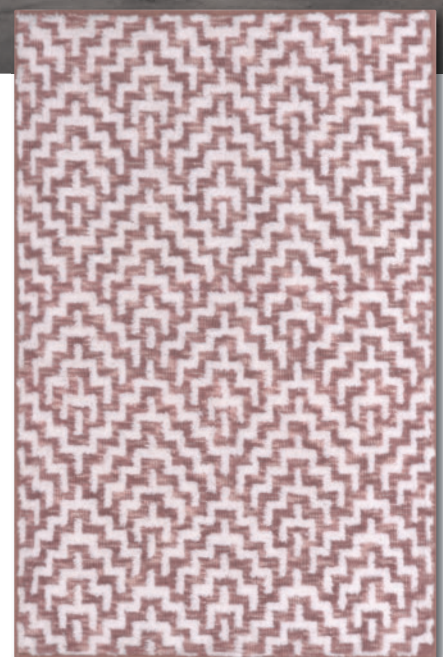

Das passt dazu:

That fits: / Ça correspond:

BOTANY

Badteppich mit modernem Rautenmotiv

Bath carpet with modern diamond motif

Tapis de bain avec motif diamant moderne

> Seite 93 / page 93

Nachhaltig denken und ökologisch handeln!

ECO CARE

ECO LIVING



Nachhaltig denken und ökologisch handeln!



LEAF
Textiler Duschvorhang
im passenden Design
Textile shower curtain in
matching design
Rideau de douche en textile
au design assorti
> Seite 208 / page 208

ECO CARE

100% Cotton



Jacquardgewebe 500g/qm

Jacquard fabric: 500 g/qm
Tissu jacquard: 500 g/qm



114
Schneeweiß



685
Maledivia



901
Anthrazit

ECO LIVING



3027 ... 262

Handtuch

Hand Towel
Serviette de toilette
ca. 50 x 100 cm

3027 ... 226

Duschtuch

Bath Towel
Serviette de bain
ca. 70 x 140 cm

LEAF
Accessoire-Serie
im zweifarbigen
Blättermotiv

With two-coloured
leaf motif
Avec un motif de feuille
bicolore

> Seite 139 / page 139



Nachhaltig denken und ökologisch handeln!

100% Cotton



Gewicht: 500 g/qm

Weight: 500 g/qm

Poids: 500 g/qm



104
Silbergrau

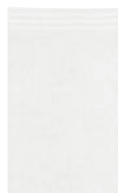

114
Schneeweiß

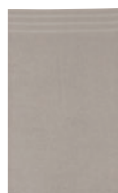

133
Basalt

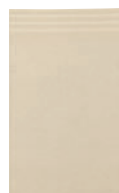

226
Sandbeige

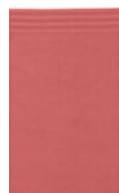

327
Marsala

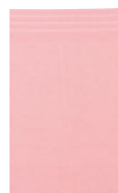

443
Magnolie



452
Burgund



607
Salbeigrün



683
Smaragd



685
Maledivia



754
Iceblue

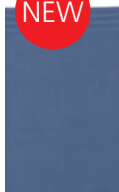

783
Mare



912
Dunkelgrau



926
Schwarz

3003 ... 201

Gäsetuch

Guest Towel

Serviette invités

ca. 30 x 50 cm

3003 ... 262

Handtuch

Hand Towel

Serviette de toilette

ca. 50 x 100 cm

3003 ... 226

Duschtuch

Bath Towel

Serviette de bain

ca. 70 x 140 cm

ECO CARE

ECO LIVING

BAMBUS



100% Bambus / Bamboo / Bambou

Für Fußbodenheizung geeignet
Suitable for underfloor heating
Approprié au chauffage de sol

Höhe (mm)

Height
Hauteur **5**



202
Natur



5043 ... 207
ca. 50 x 80 cm



5043 ... 455
ca. 60 x 115 cm

Rückseite mit Vlies ausgestattet
Reverse side fitted with fleece
Revers équipé d'un revêtement non tissé.

LEVEL



Mit Holzperlen
With wooden beads
Avec des perles en bois



100% Bambus / Bamboo / Bambou

Für Fußbodenheizung geeignet
Suitable for underfloor heating
Approprié au chauffage de sol

Höhe (mm)

Height
Hauteur **8**



202
Natur



4072 ... 207
ca. 50 x 80 cm



4072 ... 455
ca. 60 x 115 cm

Mit rutschhemmenden Moosgummistreifen
With anti-slip foam rubber strips
Avec des bandes antidérapantes

Nachhaltig denken und ökologisch handeln!

ECO CARE

ECO LIVING

Bambus –
Naturprodukt aus
nachwachsendem
Plantagenanbau

Bamboo – a natural
product harvested from
renewable plantations

Bambou - produit
naturel issu de
plantations
renouvelables



Angenehm leichte Fußmassage
durch einzelne Holz-Glieder der
Bambusmatte

Pleasant and gentle foot massage due
to the individual wooden elements of
the bamboo mat

Massage des pieds agréable, tout
en douceur, grâce à la structure
unique des composants en
bambou



100% Bambus / Bamboo / Bambou

 Für Fußbodenheizung geeignet
Suitable for underfloor heating
Approprié au chauffage de sol

Höhe (mm)

Height
Hauteur

5



9113 ... 324
ca. 50 x 70 cm

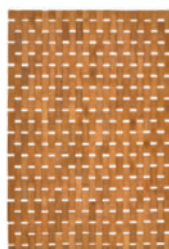

202
Natur

Mit rutschhemmenden
Moosgummistreifen

With anti-slip foam
rubber strips
Avec des bandes
antidérapantes



Die Holzmatten von Kleine Wolke sind besonders
hygienisch: Feuchtigkeit zieht nicht ein, sondern
verdunstet schnell von der Oberfläche.
Reinigung ohne Waschmaschine – einfach absaugen,
ausklopfen oder feucht abwischen.

The wooden mats from Kleine Wolke are particularly hy-
gienic: No moisture is absorbed, but instead evaporates
quickly from the surface. Clean without washing ma-
chine - simply vacuum, beat or wipe with a damp cloth.

Les tapis en latte de bois Kleine Wolke sont particuliè-
rement hygiéniques : aucune infiltration de l'humidité, qui
s'évapore rapidement à la surface de l'article. Ne pas
laver en machine – passer tout simplement l'aspirateur,
tapoter l'article ou l'essuyer à l'aide d'un chiffon humide.

Nachhaltig denken und ökologisch handeln!

ECO CARE

ECO LIVING



Kleine
Wolke®

ACCESSOIRES

ACCESSORIES / ACCESSOIRES

Attraktive Accessoires-Serien, stilistisch und farblich perfekt auf das Badezimmer abgestimmt. Abwechslungsreiche Farben, Formen und Materialien.

Attractive accessory series, perfectly coordinated to the bathroom in style and colour. Diverse colours, shapes and materials.

Séries d'accessoires attrayants, styles et couleurs parfaitement assortis à la salle de bains. Variété de couleurs, de formes et de matériaux.



ÜBERSICHT SEITE 120 - 155

Content page 120-155
Contenu page 120-155



ANTOINETTE 121



BOLSA 124



DOTTY 129



EXOTIC 133



MARMOR 143



SOAP 149

- ANCHOR 120
- ARGENTIC 120
- ANTOINETTE 121
- BENTO 122
- BELLY 123
- BLOOM 123
- BOLSA 124
- BONNY 125
- CALLISTO 126
- CHECK 126
- COOPER 127
- CRACKLE 128
- CUBIC 128
- DOTTY 129
- DOUBLE 130
- DUSTY 130
- ECLIPSE 131
- EASY 132
- EDIT 132
- EXOTIC 133
- FLASH 134
- FORTUNE 134
- GLORIA 135
- GLAMOUR 136
- GOLDEN CRACKLE 137
- JOKER 137
- KYOTO 138
- LOFT 138
- LEAF 139
- MABLE 140
- MANDALAY 140
- MERCURY 141
- MARBLE 142
- MARMOR 143
- MILA 144
- MONROE 144
- NATURA 145
- NOBLESSE 146
- PINO 146
- PUR 147
- PUR SHINY 147
- SAHARA 148
- SOAP 149
- STONES 149
- STREAM 150
- TIMBER 150
- TOUCHLESS 151
- TRICOTTA 151
- ERSATZTEILE 152-154
- Spare parts / Pièces de rechange
- SHOPWELT 155



BENTO 122



BONNY 125

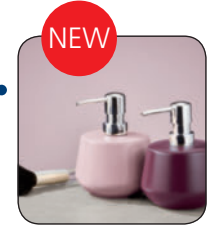

COOPER 127



ECLIPSE 131



LEAF 139



NATURA 145



TOUCHLESS 151

ANCHOR

Steinzeug / Stoneware / Object en terre cuite



789
Dunkelblau



5876 ... 852
Zahnputzbecher
Tumbler
Gobelet de brossse à dents



5876 ... 854
Seifenspender
Soap dispenser
Dispenseur de savon



5876 ... 856
WC-Bürstengarnitur
Toilet brush holder
Porte-brosse de toilette



ARGENTIC

Steinzeug / Stoneware / Object en terre cuite



325
Siena



569
Goldgelb

NEW



783
Mare

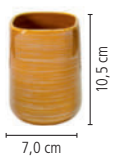

8470 ... 852
Zahnputzbecher
Tumbler
Gobelet de brossse à dents



8470 ... 854
Seifenspender
Soap dispenser
Dispenseur de savon



8470 ... 856
WC-Bürstengarnitur
Toilet brush holder
Porte-brosse de toilette



Neue
Farbe
New colour
Nouvelle
couleur

NEW



ANTOINETTE

Glas / Glass / Verre

DESIGNWELT
Magical Moments



311
Mahagoni



606
Olivgrün



8034 ... 852
Zahnputzbecher
Tumbler
Gobelet de brosse à dents



8034 ... 854
Seifenspender
Soap dispenser
Dispenseur de savon



Accessoire Serie aus Glas mit geriffelter Oberfläche
Glass accessory series with ribbed surface
Série d'accessoires en verre à surface striée

NEW



BENTO

Polystyrol



DESIGNWELT
Green Infusion



100
Weiß



698
Eucalyptus



***8027 ... 852**
Zahnputzbecher
Tumbler
Gobelet de brosses à dents



***8027 ... 854**
Seifenspender
Soap dispenser
Dispenseur de savon



8027 ... 856
WC-Bürstengarnitur
Toilet brush holder
Porte-brosse de toilette



Das passt dazu:
That fits: / Ça correspond:

MEADOW
Badteppich mit 30 mm Florhöhe
Bath rug with 30 mm pile height
Tapis de bain avec une hauteur mèches de 30 mm
> Seite 65 / page 65

*VE = 2 Stück / 2 pieces / 2 unités

DESIGNWELT Magical Moments

Glas + Silikon
Glass + silicone
Verre + silicone



Neue
Farben

New colours
Nouvelles
couleurs



Abnehmbarer Silikonfuß
Removable silicone base
Pied en silicone amovible



352
Kastanie



569
Goldgelb



606
Olivgrün



783
Mare



8,4 cm

10,2 cm

8471 ... 852
Zahnputzbecher
Tumbler
Gobelet de brosse à dents



8,4 cm

12,6 cm

8471 ... 854
Seifenspender
Soap dispenser
Dispenseur de savon



9,8 cm

36,8 cm

8471 ... 856
WC-Bürstengarnitur
Toilet brush holder
Porte-brosse de toilette

BLOOM

Porzellan / Porcelain / Porcelaine

Zweifarbigen Blütenmuster
im Art Deco Stil

Two-tone floral pattern
in Art Deco style
Motif floral bicolore
Art déco

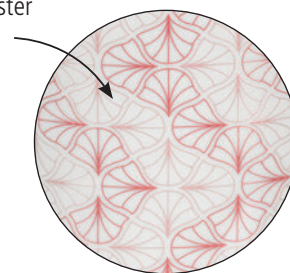

398
Pearl



6,3 cm

11,6 cm

8473 ... 852
Zahnputzbecher
Tumbler
Gobelet de brosse à dents



6,1 cm

18,5 cm

8473 ... 854
Seifenspender
Soap dispenser
Dispenseur de savon



11,2 cm

42,0 cm

8473 ... 856
WC-Bürstengarnitur
Toilet brush holder
Porte-brosse de toilette





BOLSA

Steinzeug / Stoneware / Object en terre cuite



DESIGNWELT
Nude Peach



314
Cappuccino



483
Apricot



8029 ... 851
Zahnbürstenhalter
Toothbrush holder
Porte-brosse à dents



8029 ... 854
Seifenspender
Soap dispenser
Dispenseur de savon



8029 ... 856
WC-Bürstengarnitur
Toilet brush holder
Porte-brosse de toilette



Das passt dazu:
That fits: / Ça correspond:

CONY
Weicher Badteppich in Felloptik
Soft bath rug in fur look
Tapis de bain moelleux au look fourrure
> Seite 47 / page 47

NEW



BONNY

Polyresin

DESIGNWELT Framework



100
Weiß



926
Schwarz



8035 ... 852
Zahnputzbecher
Tumbler
Gobelet de brosse à dents



8035 ... 854
Seifenspender
Soap dispenser
Dispenseur de savon



8035 ... 856
WC-Bürstengarnitur
Toilet brush holder
Porte-brosse de toilette

NEW



Das passt dazu:
That fits: / Ça correspond:

BATH
Textiler Duschvorhang mit
modernem schwarz-weiß
Aufdruck

Textile shower curtain with
modern print in black and white
Rideau de douche en textile avec
impression moderne en noir et blanc
> Seite 200 / page 200

CALLISTO

Glas / Glass / Verre



108
Milky



901
Anthrazit



5897 ... 852
Zahnputzbecher
Tumbler
Gobelet de brosses à dents



5897 ... 853
Seifenschale
Soap dish
Porte-savon



5897 ... 854
Seifenspender
Soap dispenser
Dispenseur de savon



5897 ... 848
Schaumspender
foam dispenser
Avec pompe à mousse



CHECK

Porzellan / Porcelain / Porcelaine



Hochwertige Silber-Optik
mit Schachbrett Muster

High quality silver look
with checkerboard pattern
Look argenté de haute qualité
avec motif en damier

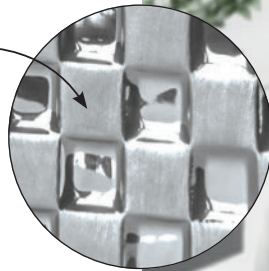

124
Silber

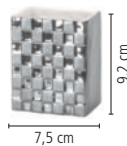

5845 ... 852
Zahnputzbecher
Tumbler
Gobelet de brosses à dents



5845 ... 854
Seifenspender
Soap dispenser
Dispenseur de savon



5845 ... 856
WC-Bürstengarnitur
Toilet brush holder
Porte-brosse de toilette



NEW

DESIGNWELT

J'adore



COOPER

Steinzeug / Stoneware / Object en terre cuite



226 Sandbeige

301 Nussbraun

481 Altrosa

496 Vino



8038 ... 854
Seifenspender
Soap dispenser
Dispenseur de savon

Das passt dazu:

That fits: / Ça correspond:

ISA

Badteppich in außergewöhnlicher Form mit schönem Farbblauf

Bath rug in extraordinary form with beautiful colour flow
Tapis de bain en forme extraordinaire avec un beau flux de couleurs

> Seite 57 / page 57

NEW

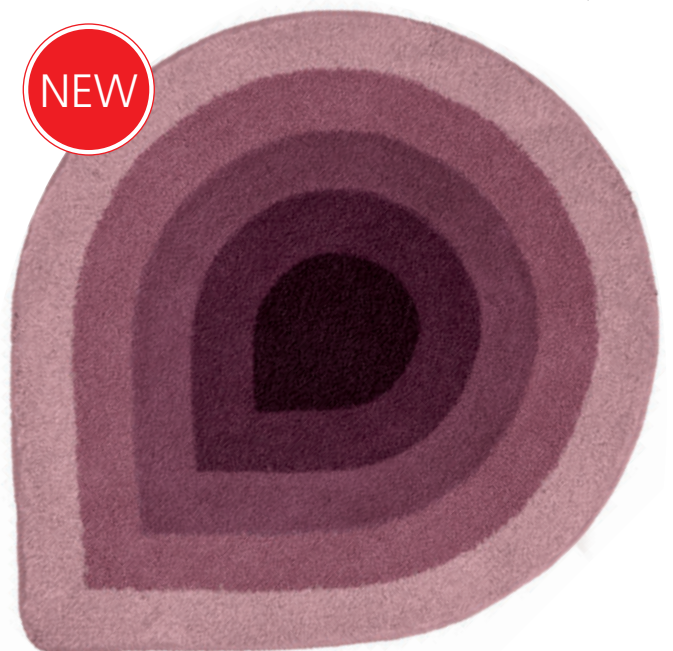

CRACKLE

Polyresin



100
Weiß



332
Rosenholz



431
Rouge



649
Opal



697
Pacific



742
Wasserblau



783
Mare



926
Schwarz

NEW



8430 ... 852
Zahnputzbecher
Tumbler
Gobelet de brossse à dents



8430 ... 854
Seifenspender
Soap dispenser
Dispenseur de savon



8430 ... 856
WC-Bürstengarnitur
Toilet brush holder
Porte-brosse de toilette



Das passt dazu:
That fits: / Ça correspond:

CRACKLE JAR
Passende Dose in 2 Farben

Matching tin in 2 colours
Boîte assortie en 2 couleurs

> Seite 166 / page 166



CUBIC

Steinzeug / Stoneware / Object en terre cuite



100
Weiß



202
Natur



413
Pastellrose



436
Beere



617
Distel



649
Opal



901
Anthrazit



5066 ... 852
Zahnputzbecher
Tumbler
Gobelet de brossse à dents

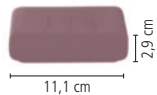

5066 ... 853
Seifenschale
Soap dish
Porte-savon



5066 ... 854
Seifenspender
Soap dispenser
Dispenseur de savon



5066 ... 856
WC-Bürstengarnitur
Toilet brush holder
Porte-brosse de toilette



NEW



DOTTY

Steinzeug / Stoneware / Object en terre cuite

DESIGNWELT
Nude Peach



100
Weiß



226
Sandbeige



483
Apricot



698
Eucalyptus



8030 ... 852
Zahnputzbecher
Tumbler
Gobelet de brosse à dents

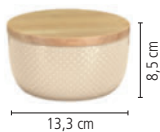

8030 ... 873
Dose
Can
Peut



8030 ... 854
Seifenspender
Soap dispenser
Dispenseur de savon



8030 ... 856
WC-Bürstengarnitur
Toilet brush holder
Porte-brosse de toilette

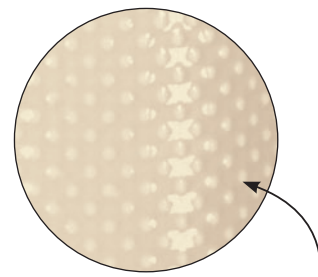

Accessoire Serie mit feiner
Pünktchen Struktur
With fine dot structure
Avec une structure à picots

DOUBLE

AS Kunststoff / AS Plastic / AS Plastique



118
Grau



226
Sandbeige



607
Salbeigrün



***5868 ... 852**
Zahnputzbecher
Tumbler
Gobelet de brosse à dents



***5868 ... 854**
Seifenspender
Soap dispenser
Dispenseur de savon



5868 ... 856
WC-Bürstengarnitur
Toilet brush holder
Porte-brosse de toilette

*VE = 2 Stück / 2 pieces / 2 unités



DUSTY

Dolomite



977
Platin



8400 ... 852
Zahnputzbecher
Tumbler
Gobelet de brosse à dents



8400 ... 854
Seifenspender
Soap dispenser
Dispenseur de savon



8400 ... 856
WC-Bürstengarnitur
Toilet brush holder
Porte-brosse de toilette

Mit exklusivem
Design-Pumpenkopf
With exclusive pump head
Avec exclusive tête de pompe



NEW



ECLIPSE

Steinzeug gummiert / Stoneware gummed / Object en terre cuite caoutchouté

DESIGNWELT
J'adore



226
Sandbeige



301
Nussbraun



496
Vino



913
Nebel

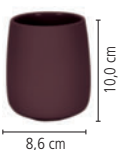

8036 ... 852
Zahnputzbecher
Tumbler
Gobelet de brosse à dents

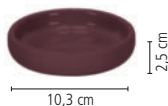

8036 ... 853
Seifenschale
Soap dish
Porte-savon



8036 ... 854
Seifenspender
Soap dispenser
Dispenseur de savon



8036 ... 856
WC-Bürstengarnitur
Toilet brush holder
Porte-brosse de toilette

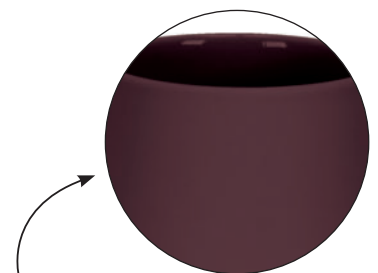

Accessoire Serie mit
gummierter Oberfläche
With rubberized surface
Avec surface caoutchoutée

EASY

AS Kunststoff / AS Plastic / AS Plastique



114
Schneeweiß



459
Mohrrot



488
Orange



645
Grün



748
Kobaltblau



766
Türkis



926
Schwarz



5061 ... 852
Zahnputzbecher
Tumbler
Gobelet de brossse à dents

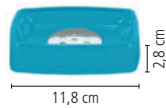

5061 ... 853
Seifenschale
Soap dish
Porte-savon



5061 ... 854
Seifenspender
Soap dispenser
Dispenseur de savon



5061 ... 856
WC-Bürstengarnitur
Toilet brush holder
Porte-brosse de toilette



EDIT

Steinzeug / Stoneware / Object en terre cuite



100
Weiß



467
Rot



617
Distel



720
Blau



***5875 ... 852**
Zahnputzbecher
Tumbler
Gobelet de brossse à dents



***5875 ... 854**
Seifenspender
Soap dispenser
Dispenseur de savon



5875 ... 856
WC-Bürstengarnitur
Toilet brush holder
Porte-brosse de toilette



*VE = 2 Stück / 2 pieces / 2 unités

NEW



EXOTIC

Polyresin



DESIGNWELT Nude Peach



100
Weiß



483
Apricot



8037 ... 852
Zahnputzbecher
Tumbler
Gobelet de brosse à dents



8037 ... 854
Seifenspender
Soap dispenser
Dispenseur de savon



8037 ... 856
WC-Bürstengarnitur
Toilet brush holder
Porte-brosse de toilette

Das passt dazu:
That fits: / Ça correspond:

EXOTIC
Textiler Duschvorhang mit
extravagantem, tropischem
Druck

Textile shower curtain with flamboyant
tropical print
Rideau de douche en textile avec une
impression tropical flamboyante

> Seite 204 / page 204



FLASH

Steinzeug / Stoneware / Object en terre cuite



114
Schneeweiß

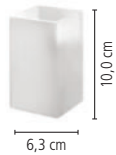

5045 ... 852
Zahnputzbecher
Tumbler
Gobelet de brosse à dents

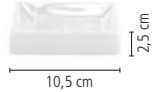

5045 ... 853
Seifenschale
Soap dish
Porte-savon



5045 ... 854
Seifenspender
Soap dispenser
Dispenseur de savon



5045 ... 849
Seifenspender Flakon
Bottle of Soap dispenser
Flacon dispenseur de savon

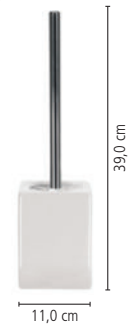

5045 ... 856
WC-Bürstengarnitur
Toilet brush holder
Porte-brosse de toilette

FORTUNE

AS Kunststoff / AS Plastic / AS Plastique



108
Milky



116
Clear



766
Türkis



5058 ... 852
Zahnputzbecher
Tumbler
Gobelet de brosse à dents

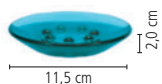

5058 ... 853
Seifenschale
Soap dish
Porte-savon



5058 ... 854
Seifenspender
Soap dispenser
Dispenseur de savon



5058 ... 856
WC-Bürstengarnitur
Toilet brush holder
Porte-brosse de toilette





124
Silber

Mit gravierten Linien
With engraved lines
Avec des lignes gravées

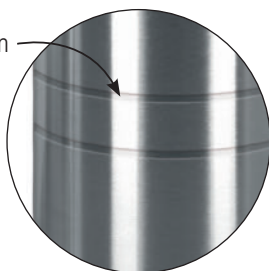

8480 ... 852
Zahnputzbecher
Tumbler
Gobelet de brosse à dents



8480 ... 853
Seifenschale
Soap dish
Porte-savon



8480 ... 854
Seifenspender
Soap dispenser
Dispenseur de savon



8480 ... 856
WC-Bürstengarnitur
Toilet brush holder
Porte-brosse de toilette

Das passt dazu:

That fits: / Ça correspond:



ELEGANCE
Treteimer mit SoftClose, 5 Liter

Pedal bin with SoftClose, content 5 litres
Poubelle à pédale avec SoftClose, contenu 5 litres
> Seite 160 / page 160

GLAMOUR

Porzellan / Porcelain / Porcelaine



124
Silber



125
Gold



5065 ... 852
Zahnputzbecher
Tumbler
Gobelet de brosse à dents



5065 ... 853
Seifenschale
Soap dish
Porte-savon



5065 ... 854
Seifenspender
Soap dispenser
Dispenseur de savon

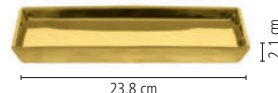

5065 ... 885
Kammschale
Comb holder
Porte-peigne



5065 ... 856
WC-Bürstengarnitur
Toilet brush holder
Porte-brosse de toilette



Das passt dazu:

That fits: / Ça correspond:



GOLDEN HOOKS
Wandhaken aus Acryl 5x5 cm
Wall hooks, acrylic 5 x 5 cm
Crochet mural, acrylique 5 x 5 cm
> Seite 173 / page 173

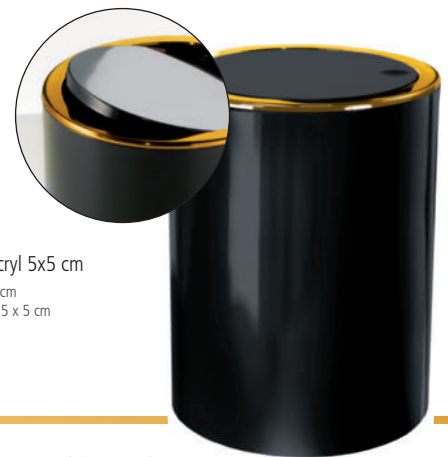

GOLDEN CLAP
Schwingdeckeleimer mit Goldrand, 5 Liter
Swing bin with with gold rim, content 5 litres
Poubelle à couvercle basculant avec bord d'or, contenu 5 litres
> Seite 159 / page 159

GRID
Textiler Duschvorhang
mit Goldeffekt
Textile shower curtain with gold effect
Rideau de douche en textile avec effet doré
> Seite 206 / page 206

GOLDEN CRACKLE

Polyresin



Formschöne Accessoire-Serie mit Gold-Akzenten

Elegant accessory series with gold accents
Série d'accessoires élégants avec des accents d'or



100
Weiß



926
Schwarz



8431 ... 852
Zahnputzbecher
Tumbler
Gobelet de brosse à dents



8431 ... 854
Seifenspender
Soap dispenser
Dispenseur de savon



8431 ... 856
WC-Bürstengarnitur
Toilet brush holder
Porte-brosse de toilette

JOKER

AS Kunststoff / AS Plastic / AS Plastique



271
Taupe



459
Mohrrot



766
Türkis



***5827 ... 852**
Zahnputzbecher
Tumbler
Gobelet de brosse à dents



***5827 ... 854**
Seifenspender
Soap dispenser
Dispenseur de savon



5827 ... 856
WC-Bürstengarnitur
Toilet brush holder
Porte-brosse de toilette

*VE = 2 Stück / 2 pieces / 2 unités

KYOTO

Polyresin mit Bambus / Polyresin with bamboo / Polyrésine avec bambou



100
Weiß



926
Schwarz



5079 ... 852
Zahnputzbecher
Tumbler
Gobelet de brosse à dents

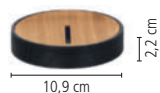

5079 ... 853
Seifenschale
Soap dish
Porte-savon



5079 ... 854
Seifenspender
Soap dispenser
Dispenseur de savon

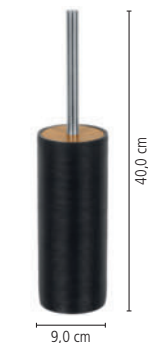

5079 ... 856
WC-Bürstengarnitur
Toilet brush holder
Porte-brosse de toilette



LOFT

Beton / Concrete / Béton



155
Steingrau



Ideal für elektrische Zahn-
bürsten und Bürstenköpfe

Ideal for electric toothbrushes
and brush heads
Idéal pour les brosses à dents
électriques et têtes de brosse

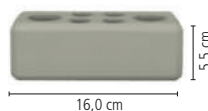
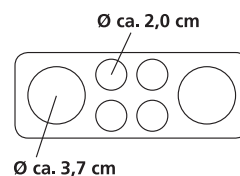

5874 ... 851
Zahnbürstenhalter
Toothbrush holder
Porte-brosse à dents



5874 ... 852
Zahnputzbecher
Tumbler
Gobelet de brosse à dents



5874 ... 853
Seifenschale
Soap dish
Porte-savon



5874 ... 854
Seifenspender
Soap dispenser
Dispenseur de savon



5874 ... 856
WC-Bürstengarnitur
Toilet brush holder
Porte-brosse de toilette

NEW



LEAF

Steinzeug / Stoneware / Object en terre cuite

DESIGNWELT Green Infusion



697
Pacific



8031 ... 852
Zahnputzbecher
Tumbler
Gobelet de brosse à dents



8031 ... 854
Seifenspender
Soap dispenser
Dispenseur de savon



8031 ... 856
WC-Bürstengarnitur
Toilet brush holder
Porte-brosse de toilette

Das passt dazu:
That fits: / Ça correspond:

LEAF
Badteppich mit Blättermotiv
aus 100% Baumwolle

Bath rug with leaf motif made of
100% cotton
Tapis de bain avec motif de feuilles
en 100% coton

> Seite 103 / page 103



MABLE

AS Kunststoff / AS Plastic / AS Plastique



114
Schneeweiß



443
Magnolie



617
Distel



977
Platin



5841 ... 852
Zahnputzbecher
Tumbler
Gobelet de brosses à dents



5841 ... 854
Seifenspender
Soap dispenser
Dispenseur de savon



5841 ... 856
WC-Bürstengarnitur
Toilet brush holder
Porte-brosse de toilette



MANDALAY

Steinzeug / Stoneware / Object en terre cuite



Farbenfrohe Accessoire-Serie
mit Präge im Mandala Stil
Colorful accessory series
with embossing in mandala style
Série d'accessoires colorés
avec gaufrage style mandala



406
Rose



607
Salbeigrün



723
Azur



858
Crocus



8474 ... 852
Zahnputzbecher
Tumbler
Gobelet de brosses à dents



8474 ... 885
Kammschale
Comb tray
Coupelle porte-peigne



8474 ... 854
Seifenspender
Soap dispenser
Dispenseur de savon

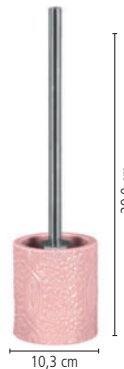

8474 ... 856
WC-Bürstengarnitur
Toilet brush holder
Porte-brosse de toilette

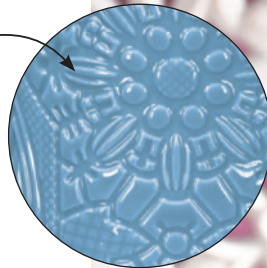



**Neue
Farbe**
New colour
Nouvelle
couleur



403
Koralle



664
Evergreen



783
Mare

NEW



5898 ... 852
Zahnputzbecher
Tumbler
Gobelet de brosse à dents



5898 ... 853
Seifenschale
Soap dish
Porte-savon



5898 ... 854
Seifenspender
Soap dispenser
Dispenseur de savon



5898 ... 856
WC-Bürstengarnitur
Toilet brush holder
Porte-brosse de toilette



Accessoires-Serie aus Glas
mit spezieller Sprengel-Optik
Accessories series of glass with special
speckle effect and gold accents
Accessoires série de verre avec effet
moucheté et accents dorés

MARBLE

Porzellan / Porcelain / Porcelaine



Elegante Accessoire Serie
in Marmor-Optik

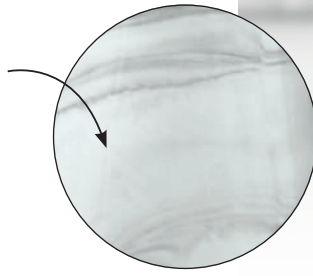

901
Anthrazit



5854 ... 852
Zahnputzbecher
Tumbler
Gobelet de brosse à dents



5854 ... 854
Seifenspender
Soap dispenser
Dispenseur de savon



5854 ... 856
WC-Bürstengarnitur
Toilet brush holder
Porte-brosse de toilette



MARBLE

Textiler Duschvorhang in Marmor-Optik

Textile shower curtain in marble look
Rideau de douche textile aspect marbre
ca. 180 x 200 cm

> Seite 210 / page 210

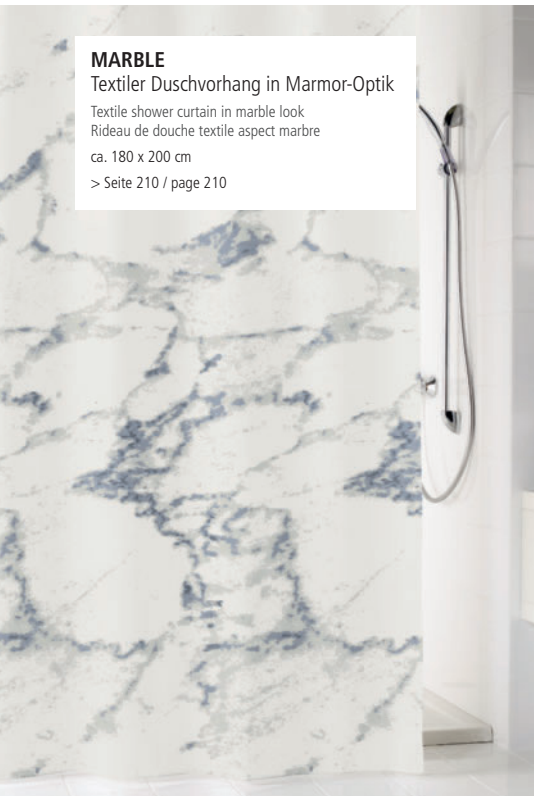

Das passt dazu:

That fits: / Ça correspond:

MARBLE

WC-Deckel in Marmor-Optik

WC seat in marble look
Abattants WC aspect marbre
ca. 37 x 45 cm

> Seite 196 / page 196



MARBLE

Sicherheitseinlagen aus PVC auch als Nackenpolster

Safety inserts made of PVC. Also available as bath head rest
Tapis anti-dérapants en PVC. Aussi comme repose-tête

> Seite 248 / page 248

NEW



MARMOR

Glas / Glass / Verre

DESIGNWELT Framework



901
Anthrazit



8033 ... 852
Zahnputzbecher
Tumbler
Gobelet de brosse à dents



8033 ... 854
Seifenspender
Soap dispenser
Dispenseur de savon



8033 ... 856
WC-Bürstengarnitur
Toilet brush holder
Porte-brosse de toilette

Das passt dazu:
That fits: / Ça correspond:

COMO
Hochwertiger Baumwoll-
Webteppich in modischem
Marmor-Design

High quality cotton woven carpet in
trendy marble design
Tapis tissé en coton de haute qualité
en le design tendance du marbre

> Seite 95 / page 95



MILA

Steinzeug / Stoneware / Object en terre cuite



100
Weiß



452
Burgund



683
Smaragd



8401 ... 852
Zahnputzbecher
Tumbler
Gobelet de brosses à dents



8401 ... 854
Seifenspender
Soap dispenser
Dispenseur de savon

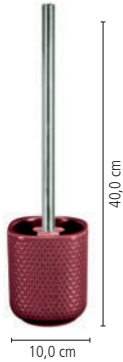

8401 ... 856
WC-Bürstengarnitur
Toilet brush holder
Porte-brosse de toilette



MONROE

Porzellan / Porcelain / Porcelaine



Accessoire-Serie aus Porzellan mit
ausgefallener Oberflächenstruktur

Accessory series of porcelain with
unusual surface structure
Série d'accessoires en porcelaine avec
structure de surface insolite

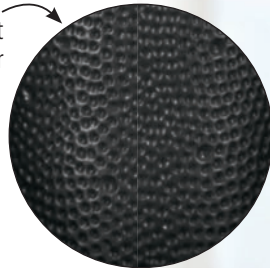

114
Schneeweiß



926
Schwarz



5810 ... 852
Zahnputzbecher
Tumbler
Gobelet de brosses à dents



5810 ... 854
Seifenspender
Soap dispenser
Dispenseur de savon



5810 ... 856
WC-Bürstengarnitur
Toilet brush holder
Porte-brosse de toilette



NEW



NATURA

Steinzeug / Stoneware / Object en terre cuite

DESIGNWELT
Nude Peach



483
Apricot



8028 ... 852
Zahnpfutzbecher
Tumbler
Gobelet de brosse à dents

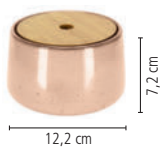

8028 ... 873
Dose
Can
Peut



8028 ... 854
Seifenspender
Soap dispenser
Dispenseur de savon



8028 ... 856
WC-Bürstengarnitur
Toilet brush holder
Porte-brosse de toilette

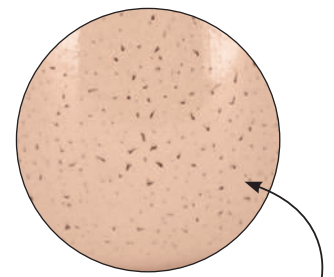

Accessoire Serie mit
gesprenkelter Natur Optik
Accessory series with speckled natural look
Série d'accessoires à l'aspect naturel moucheté

NOBLESSE

Porzellan / Porcelain / Porcelaine



127
Weiß Silber



5075 ... 852
Zahnputzbecher
Tumbler
Gobelet de brosse à dents



5075 ... 854
Seifenspender
Soap dispenser
Dispenseur de savon



5075 ... 856
WC-Bürstengarnitur
Toilet brush holder
Porte-brosse de toilette

Hochglanz Accessoire-Serie
mit edler Umrandung
Glossy accessory series
with noble border
Série haute brillance avec une
bordure noble



PINO

Polystyrol



116
Clear



901
Anthrazit



5059 ... 852
Zahnputzbecher
Tumbler
Gobelet de brosse à dents



5059 ... 854
Seifenspender
Soap dispenser
Dispenseur de savon

Accessoire-Serie in
klarer Farbe und Form
Accessory series in
clear color and shape
Série d'accessoires en
couleur et forme claire



Porzellan gummiert / Rubberised porcelain / Porcelaine gommée



Schlanke Accessoire-Serie mit gummierter Oberfläche

Slim accessory series with rubberized surface
Série d'accessoires étroit avec surface gommée



100
Weiß



901
Anthrazit



926
Schwarz



5055 ... 852
Zahnputzbecher
Tumbler
Gobelet de brosse à dents



5055 ... 848
Schaumspender
Foam dispenser
Distributeur de mousse



5055 ... 854
Seifenspender
Soap dispenser
Dispenseur de savon



5055 ... 856
WC-Bürstengarnitur
Toilet brush holder
Porte-brosse de toilette

PUR SHINY

Steinzeug / Stoneware / Object en terre cuite



114
Schneeweiß



240
Beige



411
Hummer



926
Schwarz



5084 ... 852
Zahnputzbecher
Tumbler
Gobelet de brosse à dents



5084 ... 848
Schaumspender
Foam dispenser
Distributeur de mousse



5084 ... 854
Seifenspender
Soap dispenser
Dispenseur de savon



5084 ... 856
WC-Bürstengarnitur
Toilet brush holder
Porte-brosse de toilette

SAHARA

Steinzeug / Stoneware / Object en terre cuite



100
Weiß



133
Basalt



202
Natur



685
Maledivia

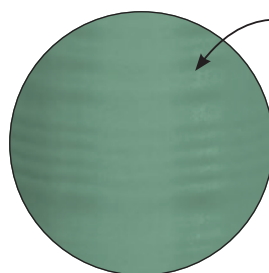

Accessoire-Serie mit ausgefallener
Oberflächenstruktur
Accessory series with fancy
surface structure
Série d'accessoires avec fantaisie
structure de surface



5046 ... 852
Zahnputzbecher
Tumbler
Gobelet de brosse à dents



5046 ... 853
Seifenschale
Soap dish
Porte-savon



5046 ... 854
Seifenspender groß
Large soap dispenser
Grand distributeur de savon



5046 ... 849
Seifenspender klein
Small soap dispenser
Petit distributeur de savon

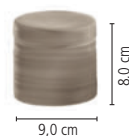

5046 ... 873
Wattdose
Cotton box
Boîte à coton



5046 ... 856
WC-Bürstengarnitur
Toilet brush holder
Porte-brosse de toilette

NEW

SOAP

Glas / Glass / Verre



926
Schwarz



Seifenspender aus Glas mit „PURE SOAP“ Präge
Glass soap dispenser with „PURE SOAP“ imprint
Distributeur de savon en verre avec „PURE SOAP“ en relief



8032 ... 854
Seifenspender
Soap dispenser
Dispenseur de savon

Das passt dazu:

That fits: / Ça correspond:

FRAMEWORK MIRROR
Kosmetikspiegel mit 1-/2-facher Vergrößerung im FRAMEWORK-Design

Cosmetic mirror with 1/2-fold magnification in FRAMEWORK design
Miroir cosmétique avec agrandissement de 1/2 fois
> Seite 188 / page 188



STONES

Polyresin



226
Sandbeige



912
Dunkelgrau



5080 ... 852
Zahnputzbecher
Tumbler
Gobelet de brosse à dents

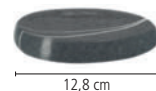

5080 ... 853
Seifenschale
Soap dish
Porte-savon



5080 ... 854
Seifenspender
Soap dispenser
Dispenseur de savon



5080 ... 856
WC-Bürstengarnitur
Toilet brush holder
Porte-brosse de toilette

STREAM

TPR / Metall / PP

WC-Bürstenhalter mit TPR-Bürstenkopf

WC-Bürstenhalter mit TPR-Bürstenkopf
WC-Bürstenhalter mit TPR-Bürstenkopf



101
Chromfarbig

8490 ... 856
WC-Bürstengarnitur
Toilet brush holder
Porte-brosse de toilette



Hygienisch
Hygienic / Hygiénique



Flexibel
Flexible / Flexible



926
Schwarz

Ersatz-Bürstenkopf aus TPR

Brush head made of TPR
Tête de brosse en TPR

8490 926 868
Bürstenkopf
Replacement toilet brush head
Tête de rechange pour brosse

TIMBER

Polystyrol mit Bambus / Polystyrol with bamboo / Polystyrol avec bambou



100
Weiß



*5877 ... 852
Zahnputzbecher
Tumbler
Gobelet de brosse à dents



*5877 ... 853
Seifenschale
Soap dish
Porte-savon



*5877 ... 854
Seifenspender
Soap dispenser
Dispenseur de savon



5877 ... 856
WC-Bürstengarnitur
Toilet brush holder
Porte-brosse de toilette

Moderne Accessoire-Serie im Material-Mix mit Bambus.
Modern accessory series in a material mix with bamboo.
Série d'accessoires modernes dans le mélange de matériaux avec du bambou.



*VE = 2 Stück / 2 pieces / 2 unités

150 CLASSIC COLLECTION

TOUCHLESS

NEW



- mit 3 Infrarotsensoren
- hygienisch und sparsam
- gummierte Oberfläche
- with 3 infrared sensors
- hygienic and economical
- gummed surface
- avec 3 capteurs infrarouges
- hygiénique et économique
- surface gommée



926
Schwarz

Einfaches Befüllen
Easy to fill
Remplissage facile



ABS

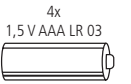

Nicht enthalten
Not included
Non inclus



8026 ... 854
Seifenspender
Soap dispenser
Dispenseur de savon

TRICOTTA

Steinzeug / Stoneware / Object en terre cuite

Stilvolle Accessoire-Serie mit handgemalten Farbakzenten

Stylish accessory series with hand-painted color accents
Série d'accessoires élégant avec accents de couleurs peints à la main



148
Multicolor

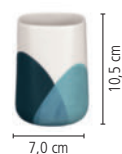

8472 ... 852
Zahnputzbecher
Tumbler
Gobelet de brosse à dents



8472 ... 854
Seifenspender
Soap dispenser
Dispenseur de savon



8472 ... 856
WC-Bürstengarnitur
Toilet brush holder
Porte-brosse de toilette



ERSATZTEILE

BÜRSTENKÖPFE UND BÜRSTEN

SPARE PARTS Toilet brush head and brushes
PIÈCES DE RECHANGE Tête de brosse et brosses

	ANCHOR 5876 ...	ARGENTIC 8470 ...	BELLY 8471 ...	BENTO 8027 ... NEW	BLOOM 8473 ...	BOLSA 8029 ... NEW	BONNY 8035 ... NEW	CHECK 5845 ...	CRACKLE 8430 ...	CUBIC 5066 ...	DOUBLE 5868 ... NEW	DOTTY 8030 ...	DUSTY 8400 ...	EASY 5061 ...	ECLIPSE 8036 ... NEW
Bürstenkopf Ø 8,2 cm Replacement toilet brush head Tête de rechange pour brosse 5060 185 868 Schwarz Weiß	●	●		●	●	●	●		●			●	●		●
Bürstenkopf Ø 8,2 cm Replacement toilet brush head Tête de rechange pour brosse 5060 926 868 Schwarz	●	●	●	●	●	●	●		●			●	●		●
Bürstenkopf Ø 7,3 cm Replacement toilet brush head Tête de rechange pour brosse 5047 185 868 Schwarz Weiß								●		●	●			●	
Bürstenkopf Ø 7,3 cm Replacement toilet brush head Tête de rechange pour brosse 5047 926 868 Schwarz								●		●	●			●	
Nur für JOKER / Only for JOKER / Seulement pour JOKER															
Bürstenkopf Ø 6,5 cm Replacement toilet brush head Tête de rechange pour brosse 5827 185 868 Schwarz Weiß															
Nur für MABLE / Only for MABLE / Seulement pour MABLE															
Bürstenkopf Ø 6,2 cm Replacement toilet brush head Tête de rechange pour brosse 5841 185 868 Schwarz Weiß															
Nur für TIMBER / Only for TIMBER / Seulement pour TIMBER															
Bürstenkopf Ø 7,3 cm Replacement toilet brush head Tête de rechange pour brosse 5877 926 868 Schwarz															
Nur für STREAM / Only for STREAM / Seulement pour STREAM															
Bürstenkopf TPR Replacement toilet brush head TPR Tête de rechange pour brosse TPR 8490 926 868 Schwarz															
Bürste Ø 8,2 cm Replacement brush Brosse de rechange 5060 117 870 Chrom	●	●		●	●	●	●		●			●	●		●
Bürste Ø 8,2 cm Replacement brush Brosse de rechange 5060 926 870 Schwarz	●	●	●	●	●	●	●		●			●	●		●
Bürste Ø 8,2 cm Replacement brush Brosse de rechange 5060 125 870 Gold															
Bürste Ø 7,3 cm Replacement brush Brosse de rechange 5047 117 870 Chrom								●		●	●				
Bürste Ø 7,3 cm Replacement brush Brosse de rechange 5047 926 870 Schwarz								●		●	●				

ERSATZTEILE

PUMPENKÖPFE

SPARE PARTS
Replacement pump head

PIÈCES DE RECHANGE
Tête de rechange pour pompe

ANCHOR



5876 124 890 Silber

ANTOINETTE **NEW**



8034 125 890 Gold

ARGENTIC



8470 124 890 Silber

BELLY



8471 352 890 Kastanie

BELLY **NEW**



8471 569 890 Goldgelb

BELLY **NEW**



8471 606 890 Olivgrün

BELLY



8471 783 890 Mare

BENTO **NEW**



8027 124 890 Silber

BLOOM



8473 124 890 Silber

BOLSA **NEW**



8029 124 890 Silber

BONNY **NEW**



8035 926 890 Schwarz

CALLISTO



5897 124 890 Silber

CALLISTO



5897 124 891 Silber

CHECK



5845 124 890 Silber

COOPER **NEW**



8038 124 890 Silber

CRACKLE



8430 124 890 Silber

CUBIC



5066 124 890 Silber

DOUBLE



5868 124 890 Silber

DOTTY **NEW**



8030 124 890 Silber

DUSTY



8400 124 890 Silber

EASY



5061 124 890 Silber

ECLIPSE **NEW**



8036 124 890 Silber

EDIT



5875 124 890 Silber

EXOTIC **NEW**



8037 124 890 Silber

FLASH



5045 117 890 Chrom

FORTUNE



5058 124 890 Silber

GLAMOUR



5065 124 890 Silber

GLAMOUR



5065 125 890 Gold

GLORIA



8480 124 890 Silber

GOLDEN CRACKLE



8431 125 890 Gold

JOKER



5827 124 890 Silber

KYOTO



5079 117 890 Chrom

LEAF **NEW**



8031 124 890 Silber

LOFT



5874 117 890 Chrom

MABLE



5841 124 890 Silber

MANDALAY



8474 124 890 Silber

MARBLE



5854 124 890 Silber

MARMOR **NEW**



8033 926 890 Schwarz

MERCURY



5898 124 890 Silber

MILA



8401 124 890 Silber

MONROE



5810 124 890 Silber

NATURA **NEW**



8028 124 890 Silber

NOBLESSE



5075 117 890 Chrom

PINO



5059 124 890 Silber

PUR / PUR SHINY



5055 124 890 Silber

PUR / PUR SHINY



5055 124 891 Silber

SAHARA



5046 117 890 Chrom

SOAP **NEW**



8032 926 890 Schwarz

STONES



5080 117 890 Chrom

TIMBER



5877 124 890 Silber

TRICOTTA



8472 124 890 Silber

Die optimale Produktpräsentation - hochwertig und individuell

Accessoires-Tisch

Alternative, warengruppen-übergreifende Platzierungsmöglichkeiten bietet die maßgeschneiderte und hochwertige Tisch-Präsentation – nicht nur für Accessoires.

The optimal product presentation - high quality and individual

Accessories table

The tailormade and high value table presentation offers alternative placement opportunities spanning different product groups.

La présentation optimale du produit - haute qualité et individuel

Table pour accessoires

Les présentations sur table personnalisées et de qualité supérieure offrent un choix alternatif aux présentations classiques de produits.





BADORGANISATION

BATH ORGANISATION

ORGANISATION POUR LA SALLE DE BAIN

Mit Kosmetikeimern, Wandhaken, Wäsche- und Aufbewahrungsboxen in vielen Varianten, Farben und Größen wird die Badorganisation perfekt.

Perfect bathroom organisation with cosmetic bins, wall hooks, laundry and storage boxes in a wide range of designs, colours and sizes.

Avec de nombreux modèles, couleurs et tailles de poubelles à cosmétiques, crochets muraux, paniers à linge et bacs de rangement, pour organiser idéalement votre espace de bains.



ÜBERSICHT SEITE 158-161

Page 158-161



CLAP 158
 CLAP MINI 159
 GOLDEN CLAP 159
 ELEGANCE 160
 GLOSSY 160
 SILENCE 161



SEITE 162-169

Page 162-169



BRAVA
 CHEVRON
 CHICO
 DOUBLE
 DOUBLE LAUNDRY
 VITA LAUNDRY
 WÄSCHEBOY
 SCANDIC CHAIR
 EASY CHAIR
 CANDLE
 CRACKLE JAR
 TISSUE
 MALVINA
 TIMBER BOX
 FRAMEWORK GRID
 FRAMEWORK BASKET
 FRAMEWORK SHELF



SCANDIC CHAIR
 165



FRAMEWORK
 GRID
 168



FRAMEWORK
 SHELF
 169

SEITE 170-177

Page 170-177

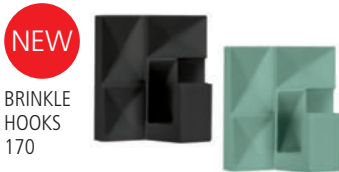

BRINKLE HOOKS
 CLASSIC HOOKS
 CRAZY HOOKS
 DROP HOOKS
 DOOR HOOKS
 EASY HOOKS
 GOLDEN HOOKS
 JOLLY HOOKS
 MARBLE HOOKS
 METAL HOOKS
 MIRA HOOKS
 MIRROR HOOKS
 SMART HOOKS
 SQUARE HOOKS
 STONES HOOK
 STATIC HOOKS
 TIMBER HOOKS



170
 170
 171
 171
 172
 172
 173
 173
 174
 174
 175
 175
 176
 176
 176
 176
 177
 177

CLAP

ABS Kunststoff
ABS Plastic
ABS Plastique

Schwingdeckeleimer
Swing bin
Poubelle à couvercle basculant

Dank des praktischen Schwingdeckels sind Abfälle schnell verschwunden.

Rubbish disappears quickly thanks to the convenient swing lid.
Le couvercle à bascule pratique permet de jeter rapidement les déchets.



114
Schneeweiß



202
Natur



414
Salmon



443
Magnolie



451
Weinrot



452
Burgund



607
Salbeigrün



617
Distel



683
Smaragd



798
Königsblau



926
Schwarz



977
Platin



Inhalt 5 Liter
Content 5 litres
Contenu 5 litres

5829 ... 858
ca. 19 x 24,5 cm

CLAP MINI



ABS Kunststoff
ABS Plastic
ABS Plastique

Schwingdeckeleimer
Swing bin
Poubelle à couvercle basculant



114
Schneeweiß



202
Natur



926
Schwarz



977
Platin



Inhalt 1,5 Liter
Content 1,5 litres
Contenu 1,5 litres

8415 ... 858
ca. 12,8 x 16,2 cm

GOLDEN CLAP



ABS Kunststoff
ABS Plastic
ABS Plastique

Schwingdeckeleimer
Swing bin
Poubelle à couvercle basculant



452
Burgund



683
Smaragd



926
Schwarz



Inhalt 5 Liter
Content 5 litres
Contenu 5 litres

8418 ... 858
ca. 19 x 24,5 cm

ELEGANCE

Edelstahl / ABS Kunststoff
Stainless steel / ABS Plastic
Acier inoxydable / ABS Plastique

Treteimer
Pedal bin
Poubelle à pédale



100
Weiß



Inhalt 5 Liter
Content 5 litres
Contenu 5 litres

8486 ... 858
ca. 20,4 x 30,2 cm

Schnelle und bequeme Öffnung
dank des Tretpedals.

Fast and convenient opening thanks
to the foot pedal.
Ouverture pratique et rapide grâce
à la pédale de propulsion.



Herausnehmbarer Innenbehälter
Removable inner container
Seau intérieur amovible



Tragegriff an der Rückseite
Handle on the back
Poignée sur le arrière

GLOSSY

Polypropylen

Schwingdeckeleimer
Swing bin
Poubelle à couvercle
basculant



115
Polarweiß

271
Taupe

466
Rot

488
Orange



625
Maigrün

766
Türkis

901
Anthrazit

926
Schwarz



Inhalt 5 Liter
Content 5 litres
Contenu 5 litres

5063 ... 858
ca. 20 x 30 cm

VE = 2 Stück / 2 pieces / 2 unités



Metall / Metal / Métal

Treteimer
Pedal bin
Poubelle à pédale

Neue
Farben
New colours
Nouvelles
couleurs



Herausnehmbarer Innenbehälter
Removable inner container
Seau intérieur amovible



3 l Inhalt 3 Liter
Content 3 litres
Contenu 3 litres

8419 ... 858
ca. 17 x 23,6 cm

BRAVA

Polypropylen

Box



VE = 4 Stück / 4 pieces / 4 unités

5862 ... 059

Box S

ca. 11,5 x 10 x 11,5 cm



Neue
Farben
New colours
Nouvelles
couleurs

DESIGNWELT
Magical Moments



VE = 4 Stück / 4 pieces / 4 unités

5862 ... 060

Box M

ca. 21,5 x 9,5 x 11 cm



100
Weiß



202
Natur



352
Kastanie



606
Olivgrün



783
Mare



977
Platin

CHEVRON

Polypropylen

Box



VE = 2 Stück / 2 pieces / 2 unités

8047 ... 059

Box S

ca. 22 x 9 x 14 cm

Bi-Color Effekt
schwarz-weiß
Bi-Color effect black and white
Effet bicolore noir et blanc



185
Schwarz-Weiß

NEW

DESIGNWELT
Framework



CHICO

Polypropylen

Box



VE = 2 Stück / 2 pieces / 2 unités

5889 ... 059

Box S

ca. 22 x 7 x 14 cm



VE = 2 Stück / 2 pieces / 2 unités

5889 ... 060

Box M

ca. 24 x 9 x 18,5 cm



VE = 2 Stück / 2 pieces / 2 unités

5889 ... 061

Box L

ca. 28 x 11,5 x 18 cm



100
Weiß



202
Natur



901
Anthrazit

Polypropylen

5880 ... 060
Box M
ca. 20 x 12 x 16,5 cm

VE = 2 Stück / 2 pieces / 2 unités



5880 ... 061
Box L
ca. 33 x 17 x 23 cm

VE = 2 Stück / 2 pieces / 2 unités

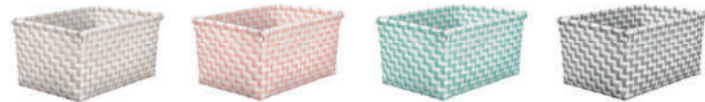

202
Natur

443
Magnolie

607
Salbeigrün

977
Platin



202
Natur



977
Platin

5882 ... 860
Laundry
ca. 35 x 50 x 35 cm

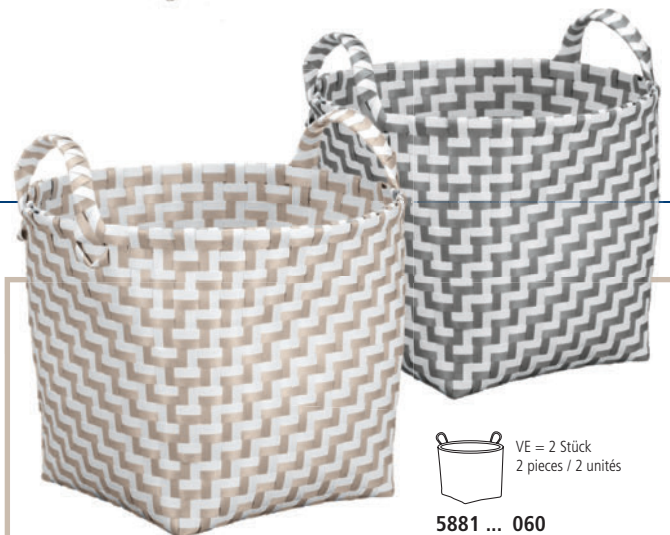

VE = 2 Stück
2 pieces / 2 unités

5881 ... 060
Basket M
ca. 30 x 25 x 30 cm

Nur in 202 Natur und 977 Platin.
Only available in 202 Natur and 977 Platin
Uniquement disponible en 202 Natur et 977 Platin

**Auch als DOUBLE BASKET und
DOUBLE LAUNDRY BOX erhältlich.**

Also as available DOUBLE BASKET and DOUBLE LAUNDRY BOX.
Aussi disponible comme DOUBLE BASKET et DOUBLE LAUNDRY BOX.



202
Natur



977
Platin



8406 ... 860
Laundry Box
ca. 35 x 55 x 35 cm

VITA LAUNDRY

Polyester

Wäschebox
Laundry box
Box à linge

Stabile Wäschebox
mit viel Platz
Stable laundry box
with a lot of space
Box à linge stable
avec beaucoup d'espace



202
Natur

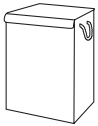

8408 ... 860
ca. 40 x 60 x 30 cm



WÄSCHEBOY

Polypropylen gewebt
Polypropylene woven
Polypropylène tissé

Wäschebox
Laundry box
Box à linge

Gewebte Oberfläche
Woven surface
Surface tissée



100
Weiß



948
Graphit

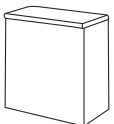

5067 ... 860
ca. 48 x 55 x 27 cm



SCANDIC CHAIR

NEW

Hocker mit 2in1 Funktion

Stool with 2in1 function
Tabouret avec fonction 2en1

Polypropylen

Hocker
Stool
Tabouret



DESIGNWELT
Framework



100
Weiß



926
Schwarz



8499 ... 889
ca. 43,5 x 43 x 43,5 cm



oder Wäschesammler
or laundry box / ou Box à linge

Nutzbar als
praktischer Badhocker
Can be used as practical stool
Peut être utilisé comme tabouret pratique

EASY CHAIR

Polypropylen

Hocker
Stool
Tabouret



www.tuv.com
ID 1111211417



100
Weiß



5847 ... 889
ca. 52,5 x 42 x 48 cm



110 kg



CANDLE

Polyresin

Teelichthalter
Tealight holder
Porte-bougies à réchaud



100
Weiß



926
Schwarz

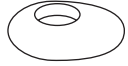

8045 ... 059
ca. 8,4 x 3,7 x 11,7 cm

Organische Form
mit Struktur
Organic form with structure
Forme organique avec structure

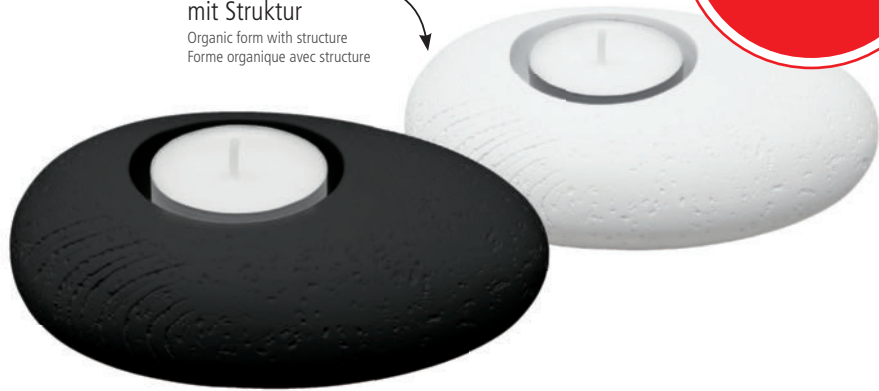

NEW

CRACKLE JAR

Polyresin

Dose
Can
Boîte



100
Weiß



926
Schwarz



8046 ... 873
ca. 10,5 x 6,0 cm

DESIGNWELT
Framework



NEW

TISSUE

Polystyrol

Box



100
Weiß



8044 ... 060
ca. 13,5 x 11,3 x 25,0 cm

DESIGNWELT
Framework



NEW

Polypropylen

Korb
Basket
Panier

Mit praktischem Haken zum Aufhängen
With practical hook to hang
Avec crochet pratique pour accrochage



100
Weiß



146
Silbergrau



406
Rose



607
Salbeigrün



VE = 2 Stück
2 pieces / 2 unités

8479 ... 059
Korb S
ca. Ø 16 cm x 10 cm



VE = 2 Stück
2 pieces / 2 unités

8479 ... 061
Korb L
ca. Ø 23 cm x 15 cm

TIMBER BOX

Polypropylen / Bambus / Glas
Polypropylene / Bamboo / Glass
Polypropylène / Bambou / Verre

Cosmetic Box
Box cosmétique

Deckel aus Bambus mit Spiegel auf der Innenseite
Cover made of bamboo with mirror on the inside
Couverture en bambou avec miroir à l'intérieur



100
Weiß

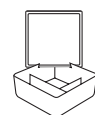

8477 ... 059
ca. 13,2 x 16,5 x 13,2 cm

FRAMEWORK GRID

Metall / Metal / Métal

Bad Organizer

Bath organizer
organisateur de salle de bains



DESIGNWELT
Framework



- 1x Wandgitter
- 1x Aufbewahrungskorb
- 1x Ablage
- 1x Doppelhaken
- 3x kleine Haken
- 1x Handtuchhalter klein
- passend zu anderen Artikeln der Serie Framework
- inkl. Befestigungsmaterial

- 1x wall grid
- 1x storage basket
- 1x shelf
- 1x double hook
- 3x small hooks
- 1x towel holder, small
- goes well with the other articles in the Framework series
- Mounting material is included

- 1x grille murale
- 1x panier de rangement
- 1x surface de dépose
- 1x double crochet
- 3x petits crochets
- 1x petit porte-serviette
- assorti à d'autres articles de la gamme Framework
- Matériel de fixation fourni

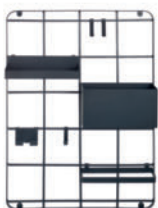

926
Schwarz

8040 ... 060
ca. 40 x 54 x 1,7 cm



Das passt dazu:
That fits: / Ça correspond:

FRAMEWORK MIRROR

Kosmetikspiegel mit
1-1/2-facher Vergrößerung
im FRAMEWORK-Design

Cosmetic mirror with
1/2-fold magnification
in FRAMEWORK design

Miroir cosmétique avec
Agrandissement de 1/2 fois

> Seite 188 / page 188



FRAMEWORK BASKET

Metall / Metal / Métal

Korb
Basket
Panier

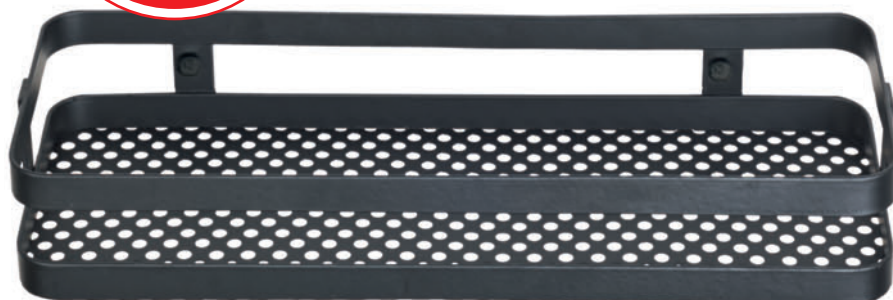

- zum Stellen oder Hängen
- passend zu anderen Artikeln der Serie Framework
- inkl. Befestigungsmaterial

- for storage or hanging
- goes well with the other articles in the Framework series
- Mounting material is included

- à poser ou à suspendre
- assorti à d'autres articles de la gamme Framework
- Matériel de fixation fourni



926
Schwarz

8041 ... 060
ca. 11 x 30,3 x 5,1 cm

FRAMEWORK SHELF

Metall / Metal / Métal

Wandregal
Wall rack
Étagère murale



- mit 3 Haken und Ablage für Badutensilien
- passend zu anderen Artikel der Serie Framework
- inkl. Befestigungsmaterial

- with 3 hooks and a shelf for bathroom items
- goes well with the other articles in the Framework series
- Mounting material is included

- avec 3 crochets et une surface de dépose pour les accessoires de bain
- assorti à d'autres articles de la gamme Framework
- Matériel de fixation fourni



926
Schwarz

8039 ... 060
ca. 12 x 50,4 x 5,2 cm

BRINKLE HOOKS

Polyresin

Wandhaken

- hohe Klebekraft
- einfach anzubringen

Wall hooks

- high adhesive power
- easy to install

Crochet mural

- résistance élevée
- fixation facile sans percer



100
Weiß



685
Malediva



926
Schwarz



977
Platin

8055 ... 887
ca. 5,0 x 5,0 cm

VE = 4 Stück / 4 pieces / 4 unités



CLASSIC HOOKS

Edelstahl

Stainless steel

Acier inoxydable

Wandhaken

- hohe Klebekraft
- einfach anzubringen

Wall hooks

- high adhesive power
- easy to install

Crochet mural

- résistance élevée
- fixation facile sans percer



Fondo
8050 ... 887
ca. 4,5 x 4,5 cm

117
Chrom

VE = 4 Stück
4 pieces / 4 unités



117
Chrom

Iseo
8049 ... 887
ca. 4,5 x 4,5 cm

VE = 4 Stück
4 pieces / 4 unités



CRAZY HOOKS

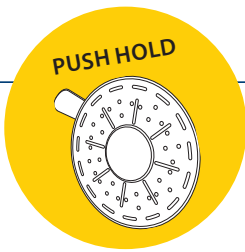

Saughaken

- hohe Saugkraft
- einfach anzubringen
- weltweit patentiert

Suction hooks

- high suction power
- easy to install
- universally patented

Crochet à ventouse

- résistance élevée
- fixation facile sans percer
- brevet international

Polystyrol



463 Cassis
488 Orange
657 Tanne



463 Cassis
488 Orange
657 Tanne



463 Cassis
488 Orange
657 Tanne



766 Türkis

Baby Bird

5069 ... 887
ca. 7,0 x 6,3 cm

VE = 4 Stück / 4 pieces / 4 unités



766 Türkis

Butterfly Lisa

5068 ... 887
ca. 7,1 x 7,5 cm

VE = 4 Stück / 4 pieces / 4 unités



766 Türkis

Kitty Kate

8403 ... 887
ca. 5,3 x 3,6 cm

VE = 4 Stück / 4 pieces / 4 unités

DROP HOOKS

Polyresin

Wandhaken

- hohe Klebekraft
- einfach anzubringen

Wall hooks

- high adhesive power
- easy to install

Crochet mural

- résistance élevée
- fixation facile sans percer



108 Milky



414 Salmon



607 Salbeigrün



720 Blau

5878 ... 887
ca. 3,2 x 6,3 cm

VE = 4 Stück / 4 pieces / 4 unités

DOOR HOOKS

Edelstahl / Stainless steel / Acier inoxydable

Türhaken
Door hooks
Crochets de porte

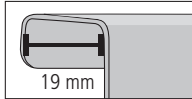

Ohne Schrauben oder Bohren. Für fast alle Türen bis zu 19 mm Falzstärke geeignet.
Z.B. Zimmertüren, Schranktüren, Garderoben, Regale, Heizungen, Gardinenstangen usw.
No screws or drilling required. Suitable for almost all doors with a thickness of up to 19mm.
E.g. room doors, cupboard doors, wardrobes, shelves, heaters, curtain rails, etc.
Sans perceuse ni vis. Compatible avec pratiquement toutes les portes d'une épaisseur de rainure max. de 19 mm.
Par ex. portes de chambre, portes d'armoire, penderies, étagères, chauffages, tringles de rideaux etc.



Single Door Hooks
2 Stück / 2 pieces / 2 unités



Double Door Hooks



Climber Door Hooks



8420 117 846
ca. 2,0 x 7,8 x 4,5 cm

VE = 4 x 2 Stück / 4 x 2 pieces / 4 x 2 unités



8421 117 846
ca. 6,8 x 6,2 x 4,7 cm

VE = 4 Stück / 4 pieces / 4 unités



8422 117 846
ca. 4,6 x 5,0 x 4,3 cm

VE = 4 Stück / 4 pieces / 4 unités

EASY HOOKS

AS Kunststoff / AS Plastic / Plastique

Saughaken

- hohe Saugkraft
- einfach anzubringen
- weltweit patentiert

Suction hooks

- high suction power
- easy to install
- universally patented

Crochet à ventouse

- résistance élevée
- fixation facile sans percer
- brevet international



114
Schneeweiß



926
Schwarz

5093 ... 887
ca. 5,5 x 7,5 cm

VE = 4 Stück
4 pieces / 4 unités



GOLDEN HOOKS

Acryl / Acrylic / Acrylique

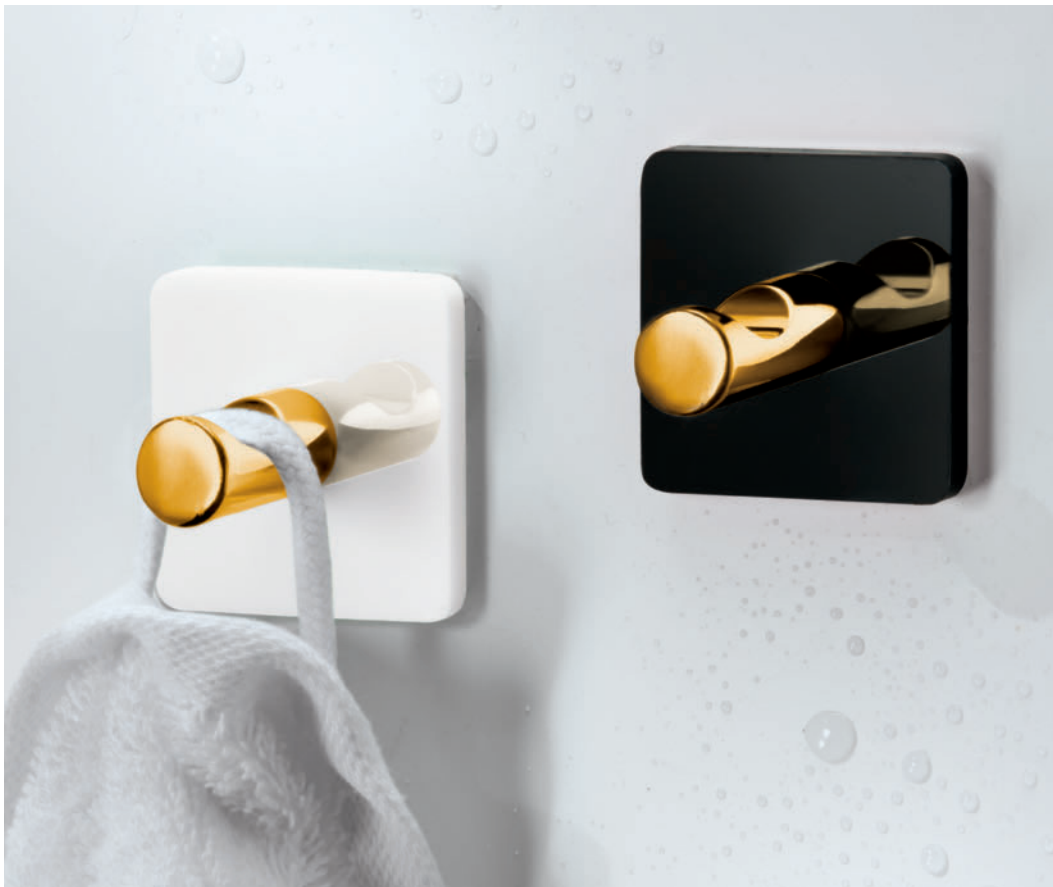

Wandhaken

- hohe Klebekraft
- einfach anzubringen

Wall hooks

- high adhesive power
- easy to install

Crochet mural

- résistance élevée
- fixation facile sans percer



114
Schneeweiß



926
Schwarz

8404 ... 887
ca. 5,0 x 5,0 cm

VE = 4 Stück / 4 pieces / 4 unités



JOLLY HOOKS

Wandhaken

- hohe Klebekraft
- einfach anzubringen

Wall hooks

- high adhesive power
- easy to install

Crochet mural

- résistance élevée
- fixation facile sans percer

AS / ABS Kunststoff

AS/ABS Plastic

AS/ABS Plastique



100 Weiß



685 Maledivia



100 Weiß



685 Maledivia

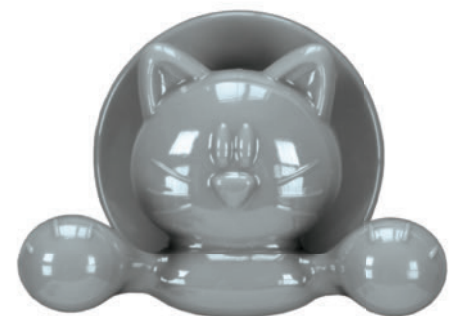

100 Weiß



685 Maledivia



977 Platin

Jolly Bird

8052 ... 887
ca. 7,3 x 7,0 cm

VE = 4 Stück / 4 pieces / 4 unités



977 Platin

Jolly Butterfly

8054 ... 887
ca. 8,1 x 6,9 cm

VE = 4 Stück / 4 pieces / 4 unités

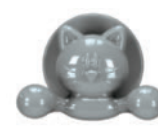

977 Platin

Jolly Cat

8053... 887
ca. 8,3 x 4,8 cm

VE = 4 Stück / 4 pieces / 4 unités

MARBLE HOOKS

Marmor + Zink
Marble + Zinc
Marbre + Zinc

Wandhaken

- hohe Klebekraft
- einfach anzubringen

Wall hooks

- high adhesive power
- easy to install

Crochet mural

- résistance élevée
- fixation facile sans percer



100
Weiß



155
Steingrau



926
Schwarz

8405 ... 887
Ø ca. 5,0 cm

VE = 4 Stück / 4 pieces / 4 unités



METAL HOOKS

Edelstahl
Stainless steel / Acier inoxydable

Wandhaken

- hohe Klebekraft
- einfach anzubringen

Wall hooks

- high adhesive power
- easy to install

Crochet mural

- résistance élevée
- fixation facile sans percer



Star, 2 Stück
2 pieces / 2 unités

5811 ... 887
ca. 6,5 x 6,5 cm

117
Chrom

VE = 4 x 2 Stück
4 x 2 pieces / 4 x 2 unités



Hoppy 2 Stück
2 pieces / 2 unités

5812 ... 887
ca. 4,0 x 8,5 cm

117
Chrom

VE = 4 x 2 Stück
4 x 2 pieces / 4 x 2 unités



MIRA HOOKS

NEW



ABS / Glas
ABS / Glass
ABS / Verre

Wandhaken

- hohe Klebekraft
- einfach anzubringen

Wall hooks

- high adhesive power
- easy to install

Crochet mural

- résistance élevée
- fixation facile sans percer



100
Weiß

926
Schwarz

8051 ... 887
ca. 7,4 x 12,7 cm

VE = 4 Stück / 4 pieces / 4 unités

MIRROR HOOKS



Acryl / Acrylic / Acrylique

Wandhaken

- hohe Klebekraft
- einfach anzubringen

Wall hooks

- high adhesive power
- easy to install

Crochet mural

- résistance élevée
- fixation facile sans percer



124
Silber

5856 ... 887
ca. 5,0 x 5,0 cm

VE = 4 Stück / 4 pieces / 4 unités

SMART HOOKS

Zink / PVC
Zinc / PVC

Saughaken

- hohe Saugkraft
- einfach anzubringen
- weltweit patentiert

Suction hooks
Crochet à ventouse



124
Silber
VE = 4 Stück
4 pieces / 4 unités

Cordoba
5089 ... 887
ca. Ø 6,8 cm

Granada
5088 ... 887
ca. Ø 6,8 cm

Marbella
5086 ... 887
ca. Ø 6,8 cm

Sevilla
5087 ... 887
ca. Ø 6,8 cm

SQUARE HOOKS

Acryl / Acrylic / Acrylique

Wandhaken

- hohe Klebekraft
- einfach anzubringen

Wall hooks
Crochet mural



114
Schneeweiß

926
Schwarz

5857 ... 887
ca. 5,0 x 5,0 cm

VE = 4 Stück / 4 pieces / 4 unités



STONES HOOK

Polyresin

Wandhaken

- hohe Klebekraft
- einfach anzubringen

Wall hooks
Crochet mural



226
Sandbeige

8056 ... 887
ca. 5,0 x 5,0 cm

VE = 4 Stück / 4 pieces / 4 unités

Mit Steinoptik
Stone optics
Optique des pierres

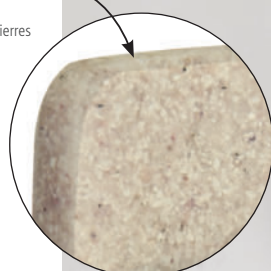

NEW



Butterflies

8410 ... 887

ca. Ø 7,7 cm

VE = 4 Stück / 4 pieces / 4 unités

148

Multicolor



Cat

8411 ... 887

ca. Ø 7,7 cm

VE = 4 Stück / 4 pieces / 4 unités

148

Multicolor



Chrome

8416 ... 887

ca. Ø 7,7 cm

VE = 4 Stück / 4 pieces / 4 unités

101

Chromfarbig

Kunststoff
Plastic
Plastique

Wandhaken

- wiederverwendbar
- leicht abziehbar
- geeignet für alle glatten Oberflächen

Wall hooks

- reusable
- easy to remove
- suitable for any smooth surface

Crochet mural

- réutilisable
- simple à décrocher
- convient à toutes les surfaces lisses



Dog

8412 ... 887

ca. Ø 7,7 cm

VE = 4 Stück / 4 pieces / 4 unités

148

Multicolor



Transparent

8417 ... 887

ca. Ø 7,7 cm

VE = 4 Stück / 4 pieces / 4 unités

116

Clear



Wave

8414 ... 887

ca. Ø 7,7 cm

VE = 4 Stück / 4 pieces / 4 unités

720

Blau



TIMBER HOOKS



Bambus / Bamboo / Bambou

Wandhaken

- hohe Klebekraft
- einfach anzubringen

Wall hooks

Crochet mural



202

Natur

5879 ... 887

ca. 5,0 x 5,0 cm

VE = 4 Stück / 4 pieces / 4 unités



KOSMETIKSPIEGEL

COSMETIC MIRROR
MIROIR DE MAQUILLAGE





LADY MIRROR
186



MINI MIRROR 188

BASE MIRROR	180
BLADE MIRROR	180
BRIGHT MIRROR	181
LED LIGHT	
BRIGHT MIRROR SHORTY	181
LED LIGHT	
BRILLIANT MIRROR	182
LED LIGHT	
CLEVER MIRROR	182
CRYSTAL MIRROR	183
EASY MIRROR	183
FLEXY COLOR	184
FLEXY LIGHT	184
LED LIGHT	
GENIUS MIRROR	185
LED LIGHT	
LADY MIRROR	186
LED LIGHT	
LUMI MIRROR	187
LED LIGHT	
FRAMEWORK MIRROR	188
MINI MIRROR	188
MOVE MIRROR	189
MULTI MIRROR	189
RIDGE MIRROR	190
TIMBER MIRROR	190
TRANSPARENT MIRROR	191
TRAY MIRROR	191



BASE MIRROR
180



FRAMEWORK MIRROR
188

BASE MIRROR

Metall chromiert + Glas / Chrome-plated metal + glass / Métal chromé + verre

Kosmetikspiegel

- 1-/5-fache Vergrößerung
- verchromt glänzend
- stabiler Standfuß

Cosmetic mirror

- 1-/5-fold enlargement
- chromed shiny
- stable case

Miroir de maquillage

- grossissement 1/5
- chromé brillant
- pied stable



124
Silber

8424 124 886
ca. 17 x 33 x 12 cm



Schwenkbarer Spiegel zum Wechsel der Vergrößerungen.

Swiveling mirror for changing the enlargements.
Miroir pivotant pour changer les élargissements.

BLADE MIRROR

Metall chromiert + Glas / Chrome-plated metal + glass / Métal chromé + verre

Kosmetikspiegel

- 5-fache Vergrößerung
- hochwertiger Chromrand
- hohe Saugkraft

Cosmetic mirror

- 5-fold enlargement
- high-grade chrome edge
- high suction power

Miroir de maquillage

- grossissement x5
- bordure chromée de qualité
- force de succion élevée



124
Silber

8423 124 886
ca. 15 x 15 x 3,5 cm



Rückseite mit Saugnäpfen zur einfachen Befestigung

Back with suction cups for easy attachment
Arrière avec ventouses pour une fixation facile

BRIGHT MIRROR

Metall chromiert + Glas / Chrome-plated metal + glass / Métal chromé + verre

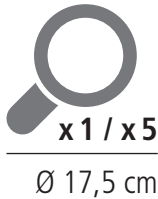

LED LIGHT

Touch



LED-Kosmetikspiegel

- 1-/5-fache Vergrößerung
- mit Chrom-Standfuß
- mit LED-Beleuchtung

LED-Cosmetic mirror

- 1-/5-fold enlargement
- with chrome base
- with LED lights

LED-Miroir de maquillage

- grossissement 1/5
- avec pied en chrome
- avec éclairage LED

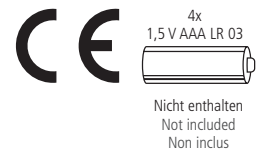

124
Silber

5887 124 886
ca. 17,5 x 29,5 x 12 cm

BRIGHT MIRROR SHORTY

Metall chromiert + Glas / Chrome-plated metal + glass / Métal chromé + verre



LED LIGHT

Touch



LED-Kosmetikspiegel

- 1-/5-fache Vergrößerung
- mit LED-Beleuchtung

LED-Cosmetic mirror

- 1-/5-fold enlargement
- with LED lights

LED-Miroir de maquillage

- grossissement 1/5
- avec éclairage LED

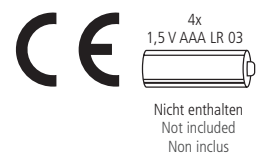

124
Silber

5886 124 886
ca. 20 x 19,5 x 4 cm

BRILLIANT MIRROR

Metall chromiert + Glas / Chrome-plated metal + glass / Métal chromé + verre

LED-Kosmetikspiegel

- mit LED-Beleuchtung
- beweglicher Gelenkarm
- drehbar um 360°
- inkl. Befestigungsmaterial

LED-Cosmetic mirror

- with LED lights
- movable jointed arm
- rotatable by 360°
- mounting material is included

LED-Miroir de maquillage

- avec éclairage LED
- bras articulé mobile
- pivote à 360°
- matériel de fixation fourni



124
Silber

8428 124 886
ca. 25 x 27 x 3,5 cm

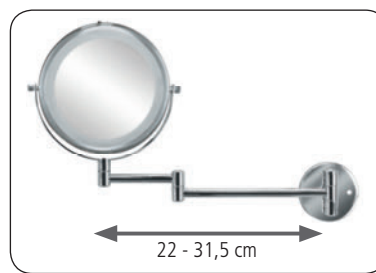

CLEVER MIRROR

Bambus + Glas / Bamboo + glass / Bambou + verre

Kosmetikspiegel

- mit Bambus-Rückseite
- zum Hängen oder Stellen
- einfach zu transportieren

Cosmetic mirror

- with LED lights
- reverse side made of bamboo
- can be used as either hanging or standing mirror
- easy to carry

Miroir de maquillage

- avec arrière en bambou
- à accrocher et à poser
- simple à transporter



202
Natur

5883 202 886
ca. 15 x 21 x 1,5 cm

Der clevere Wand-
oder Standspiegel

The cosmetic mirror can
be used either hanging or
standing mirror.
Le miroir intelligent
à accrocher et à poser.

CRYSTAL MIRROR

Metall chromiert + Glas / Chrome-plated metal + glass / Métal chromé + verre



x3

Ø 17 cm



Kosmetikspiegel

- 3-fache Vergrößerung
- mit Glas-Standfuß
- dreh- und schwenkbar

Cosmetic mirror

- 3-fold enlargement
- with glass base
- rotatable and pivotable

Miroir de maquillage

- grossissement x3
- avec pied en verre
- rotatif et pivotant



926
Schwarz

5888 926 886
ca. 17 x 28 x 15 cm

EASY MIRROR

Polystyrol + Glas / Polystyrene + glass / Polystyrène + verre



x5

Ø 15,3 cm



Rückseite mit Saugnäpfen
zur einfachen Befestigung

Back with suction cups
for easy attachment
Arrière avec ventouses
pour une fixation facile

Kosmetikspiegel

- 5-fache Vergrößerung
- hohe Saugkraft

Cosmetic mirror

- 5-fold enlargement
- strong suction

Miroir de maquillage

- grossissement x5
- puissante ventouse



116
Clear



926
Schwarz

5098 ... 886
ca. 15,3 x 15,3 x 2,5 cm

FLEXY COLOR

Polystyrol + Glas / Polystyrene + glass / Polystyrène + verre

Kosmetikspiegel mit Gelenk

- 5-fache Vergrößerung
- flexibel durch Kugel-Gelenk
- verstärkte Saufkraft durch Dreh-Funktion

Cosmetic mirror with joint

- 5 fold enlargement
- flexible due to ball-and-socket joint
- increased suction power due to rotation function

Miroir de maquillage avec l'articulation sphéroïdale

- grossissement x5
- flexible grâce à l'articulation sphéroïdale
- force d'adhésion renforcée de la ventouse grâce à la fonction rotative



Ø 17,5 cm

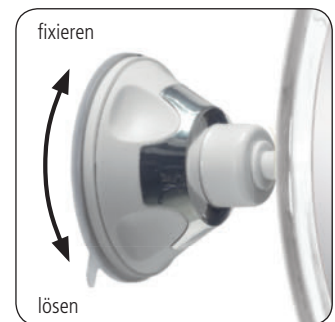

116
Clear

5820 116 886
ca. 17,5 x 17,5 x 10,5 cm

FLEXY LIGHT

Polystyrol + Glas / Polystyrene + glass / Polystyrène + verre

LED-Kosmetikspiegel mit Gelenk

- mit LED-Beleuchtung
- 5-fache Vergrößerung
- flexibel durch Kugel-Gelenk
- verstärkte Saufkraft durch Dreh-Funktion

LED-Cosmetic mirror with joint

- with LED lights
- 5 fold enlargement
- flexible due to ball-and-socket joint
- increased suction power due to rotation function

LED-Miroir de maquillage avec l'articulation sphéroïdale

- avec éclairage LED
- grossissement x5
- flexible grâce à l'articulation sphéroïdale
- force d'adhésion renforcée de la ventouse grâce à la fonction rotative



Ø 17,5 cm

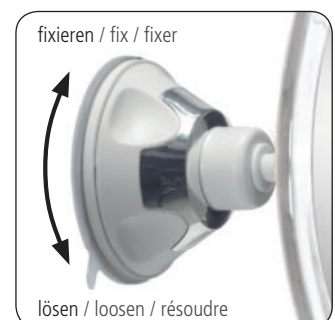

114
Schneeweiß

5819 114 886
ca. 17,5 x 17,5 x 10,5 cm

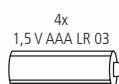

Nicht enthalten
Not included / Non inclus



GENIUS MIRROR

ABS Kunststoff + Glas / ABS plastic + glass / ABS plastique + verre

reddot award 2018
winner



Ø 23,0 cm



Ø 11,0 cm

Abnehmbarer Magnet-Aufsatzspiegel
Removable mirror with magnetic attachment
Rehausse de miroir aimantée amovible

LED LIGHT

LED-Kosmetikspiegel

- mit vielen Extras

LED-Cosmetic mirror

- with many features

LED-Miroir de maquillage

- avec de nombreuses fonctionnalités



Magnetischer Bereich
Magnetic area
Zone magnétique



LED Beleuchtung dimmbar

Dimmable LED lighting
Éclairage LED variable



3 wählbare Lichttemperaturen

3 selectable light temperatures
3 températures lumineuses au choix

Lampenfunktion

Suitable as a table lamp
Convient comme lampe de table



Bluetooth-Lautsprecher

Bluetooth loudspeaker
Enceinte Bluetooth

Bluetooth™

Bluetooth Funktion (Reichweite bis 10 m)

Knopf länger gedrückt halten, um das Gerät inkl. Bluetooth ein- oder auszuschalten. Der Punkt leuchtet blau. Knopf kurz drücken, um abgespielte Musik zu pausieren und wieder weiter abzuspielen. Nach 3 Minuten im Stand-By Modus schaltet sich die Bluetooth-Funktion selbstständig aus.

Bluetooth function (range up to 10 m)

Press and hold the button to switch the device (including Bluetooth) on or off. The button lights up blue. Press the button briefly to pause or resume playing music. After 3 minutes in stand-by mode, the Bluetooth function switches itself off automatically.

Fonction Bluetooth (portée jusqu'à 10 m)

Maintenir le bouton pressé, afin d'activer ou de désactiver l'appareil et son Bluetooth. Le bouton clignote en bleu. Appuyer brièvement sur le bouton, afin de mettre en pause la musique, ou de reprendre sa lecture. Après 3 minutes en mode Veille, la fonction Bluetooth s'éteint automatiquement.

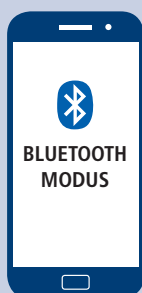

Verbinden

Bluetooth Modus in den Einstellungen des mobilen Gerätes aktivieren und mit dem Spiegel verbinden. **Gerätename: RM249-DL**

Connecting

Activate Bluetooth mode in the settings of the mobile device and connect to the mirror. **Device name: RM249-DL**

Connexion

Activer le mode Bluetooth disponible dans les réglages de l'appareil mobile, et le connecter avec le miroir. **Nom de l'appareil : RM249-DL**



Aufladen

USB Kabel an PC, Power Bank oder mit einem USB-Adapter an der Steckdose anschließen und aufladen.

- **Ladevorgang**
Lämpchen leuchtet rot
- **Aufgeladen**
Lämpchen leuchtet blau

Charging

Connect the USB cable to a PC, power bank or plug socket using a USB adapter and charge.

- **Charging** Lamp lights up red
- **Charged** Lamp lights up blue

Chargement

Connecter le câble USB à un PC, une batterie de secours Power Bank ou à une prise électrique par le biais d'un adaptateur USB et effectuer le chargement.

- **Recharge** La lampe s'allume en rouge
- **Chargé** La lampe s'allume en bleu



inkl. USB-Kabel

USB cable included / Câble USB fourni



100
Weiß

8429 ... 886

ca. 23 x 34,5 x 12,5 cm

LADY MIRROR

ABS Kunststoff + Glas / ABS plastic + glass / ABS plastique + verre

LED-Standspiegel

- mit LED-Beleuchtung
- abnehmbarer Magnetspiegelaufsatz mit 5-facher Vergrößerung
- Touch Sensor und Dimm-Funktion
- Ladefunktion über USB Anschluss (USB-Kabel inkl.)



Ø 21,0 cm



Ø 10,0 cm

LED LIGHT

Magnetischer Bereich

Magnetic area
Zone magnétique

Touch

LED-Cosmetic mirror

- with LED lights
- removable mirror with magnetic attachment
- Touch function and dimmable lighting
- charging via USB port (USB cabel included)

LED-Miroir de maquillage

- avec éclairage LED
- rehausse de miroir aimantée amovible
- fonction tactile et éclairage variable
- chargement via le port USB (câble USB fourni)



100
Weiß

8478 100 886
ca. 21 x 34 x 9 cm



Aufladen

USB Kabel an PC, Power Bank oder mit einem USB-Adapter an der Steckdose anschließen und aufladen.

- **Ladevorgang**
Lämpchen leuchtet rot
- **Aufgeladen**
Lämpchen leuchtet blau

Beleuchtung

Touch-Sensor berühren, um Beleuchtung an- und auszuschalten. Sensor lange gedrückt halten, um die Helligkeit anzupassen.

Lighting

Touch the touch sensor to switch the light on and off. Hold it down to adjust the brightness.

Éclairage

Toucher le bouton tactile pour allumer et éteindre l'éclairage. Maintenez ce bouton pressé pour ajuster la luminosité.

Charging

Connect the USB cable to a PC, power bank or plug socket using a USB adapter and charge.

- **Charging** Lamp lights up red
- **Charged** Lamp lights up blue

Chargement

Connecter le câble USB à un PC, une batterie de secours Power Bank ou à une prise électrique par le biais d'un adaptateur USB et effectuer le chargement.

- **Recharge** La lampe s'allume en rouge
- **Chargé** La lampe s'allume en bleu

LUMI MIRROR

Metall chromiert + Glas / Chrome-plated metal + glass / Métal chromé + verre



LED-Kosmetikspiegel

- 1-/7-fache Vergrößerung
- mit 3 Lichttemperaturen
- beweglicher Gelenkarm
- drehbar um 360°
- inkl. Befestigungsmaterial

LED-Cosmetic mirror

- 1/7 fold enlargement
- 3 selectable light temperatures
- movable jointed arm
- rotatable by 360°
- mounting material is included

LED-Miroir de maquillage

- grossissement x1/x7
- 3 températures lumineuses au choix
- bras articulé mobile
- pivote à 360°
- matériel de fixation fourni

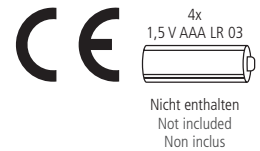

Lichttemperatur

Touch-Sensor antippen, um Lichttemperatur (Kalt, Warm oder Normal) zu wechseln.

Light temperature

Touch the touch sensor, to select light temperature (cold, warm or normal)

Températures lumineuses

Touchez le capteur tactile pour modifier la température de la lumière (froid, chaud ou normal).

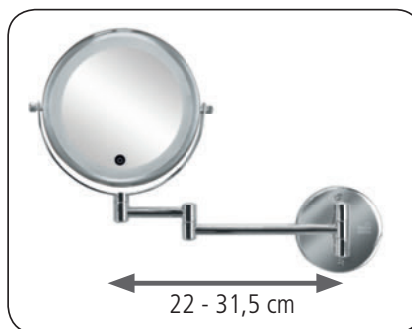

124
Silber

8487 124 886
ca. 29 x 36 x 4,0 cm

FRAMEWORK MIRROR

Metall + Glas / Metal + glass / Métal + verre

NEW

Kosmetikspiegel

- 1-/2- fache Vergrößerung
- passend zu anderen Artikeln der Serie Framework

Cosmetic mirror

- 1x/2x magnification
- goes well with the other articles in the Framework series

Miroir de maquillage

- Grossissement x1/x2
- assorti à d'autres articles de la gamme Framework



Ø 15 cm



926
Schwarz

8042 926 886
ca. 17,5 x 9,5 x 8 cm

MINI MIRROR

EVA / Glas

NEW

Klebespiegel

- einfach anzubringen
- 3-fache Vergrößerung

Adhesive mirror

- easy to install
- 3x magnification

Miroir adhésif

- fixation facile sans percer
- Grossissement x3



Ø 12,0 cm

Rückseite mit Klebepunkt
Backside with glue dot
Derrière avec point de colle



124
Silber

8057 124 886
ca. 12 x 12 x 0,5 cm

MOVE MIRROR

Metall chromiert + Glas / Chrome-plated metal + glass / Métal chromé + verre

x1 / x5
Ø 17,0 cm



124
Silber

8426 124 886
ca. 20 x 37,5 x 2 cm

Kosmetikspiegel

- schwenkbarer und ausziehbarer Arm
- drehbar um 360°
- inkl. Befestigungsmaterial

Cosmetic mirror

- swivel mounted and extendable arm
- rotatable by 360°
- mounting material is included

Miroir de maquillage

- bras extensible et pivotant
- pivote à 360°
- matériel de fixation fourni

MULTI MIRROR

Polystyrol + Glas / Polystyrene + glass / Polystyrène + verre



x1 / x5
Ø 13,8 cm

Kosmetikspiegel

- multifunktional
- zusammenklappbar zum Verstauen
- ideal für die Reise

Cosmetic mirror

- multi-functional
- collapsible for compact storage
- ideal for travel

Miroir de maquillage

- multifonctionnelle
- Pliable pour un rangement facilité
- idéale en voyage



116
Clear



926
Schwarz

5840 ... 886
ca. 13,8 x 24,5 x 1,2 cm

RIDGE MIRROR

Metall chromiert + Glas / Chrome-plated metal + glass / Métal chromé + verre

Kosmetikspiegel

- beweglicher Gelenkarm
- drehbar um 360°
- inkl. Befestigungsmaterial

Cosmetic mirror

- movable jointed arm
- rotatable by 360°
- mounting material is included

Miroir de maquillage

- bras articulé mobile
- pivote à 360°
- matériel de fixation fourni



124
Silber

8427 124 886
ca. 24,6 x 26 x 3,5 cm

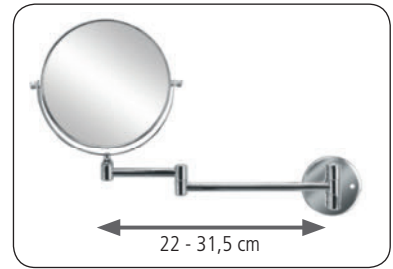

TIMBER MIRROR

Bambus + Metall chromiert + Glas / Bamboo + chrome-plated metal + glass / Bambou + métal chromé + verre

Kosmetikspiegel

- mit Bambus-Standfuß
- mit praktischem Fach für Schmuck, Kosmetik, etc.

Cosmetic mirror

- Bamboo base
- useful compartment for jewellery, make-up etc.

Miroir de maquillage

- avec pied en bambou
- avec compartiment pratique pour les bijoux, produits cosmétiques etc.



202
Natur

5884 202 886
ca. 17 x 30,5 x 14 cm

TRANSPARENT MIRROR

Polystyrol + Metall chromiert + Glas / Polystyrene + chrome-plated metal + glass / Polystyrène + métal chromé + verre



Schwenkbarer Spiegel zum Wechsel der Vergrößerungen.

Swiveling mirror for changing the enlargements.
Miroir pivotant pour changer les élargissements.



Kosmetikspiegel

- 1-/5-fache Vergrößerung
- mit Chrom-Standfuß
- mit transparentem Rahmen

Cosmetic mirror

- 1-/5-fold enlargement
- with chrome baser
- with transparent frame

Miroir de maquillage

- grossissement x1/x5
- avec pied en chrome
- avec cadre transparent



116
Clear

5885 116 886
ca. 20 x 34,5 x 15 cm

TRAY MIRROR

Polyresin + Glas / Polyresin + glass / Polyresin + verre

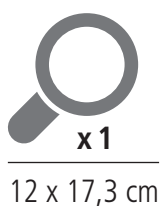

Kosmetikspiegel

- quer und hochkant nutzbar
- mit praktischer Ablage für Schmuck, Kosmetik etc.

Cosmetic mirror

- can be used horizontally and vertically
- useful compartment for jewellery, make-up etc.

Miroir de maquillage

- utilisable à l'horizontale et à la verticale
- avec compartiment pratique pour les bijoux, produits cosmétiques etc.



100
Weiß

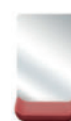

332
Rosenholz



649
Opal



783
Mare

8476 ... 886
ca. 12 x 17,3 cm



STATIC DECO ELEMENTS

Statisch haftende Dekorations-Elemente für's Bad

- geeignet für alle glatten Oberflächen
- statisch haftend ohne Kleber
- rückstandsfrei ablösbar
- unbegrenzt wiederverwendbar
- beidseitig bedruckt
- sehr einfache Handhabung
- frei von gefährlichen Inhaltsstoffen
- phthalatfrei

Static cling film for bathroom decoration

- suitable for any smooth surfac
- static cling film without adhesive
- removable without residues
- endlessly reusable
- printed on both sides
- easy to use
- free of any dangerous substances
- phthalate-free

Film électrostatique pour décorer les salles de bains

- convient à toutes les surfaces lisses
- électrostatique, pas besoin de colle
- ne laisse aucun résidu
- réutilisable
- imprimé des deux cotés
- facile à utiliser
- dépourvu de substances dangereuses
- sans phthalates



BLUBB 15 x 23,5 cm

26 Deco-Elemente / 26 deco elements / 26 éléments de déco

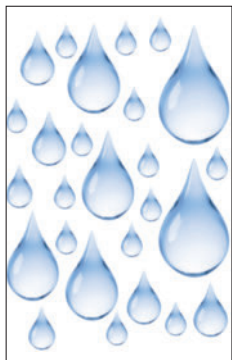

Elemente einzeln ablösbar
Individually detachable elements
Éléments détachables

1908 742 836
Wasserblau

BUTTERFLY 15 x 23,5 cm

21 Deco-Elemente / 21 deco elements / 21 éléments de déco

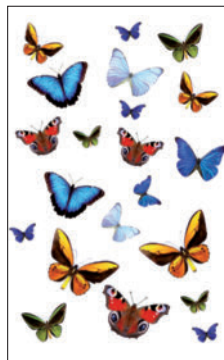

Elemente einzeln ablösbar
Individually detachable elements
Éléments détachables

1907 148 836
Multicolor

OCEAN 15 x 23,5 cm

18 Deco-Element / 18 deco elements / 18 éléments de déco



Elemente einzeln ablösbar
Individually detachable elements
Éléments détachables

1914 202 836
Natur

STONE 15 x 23,5 cm

20 Deco-Elemente / 20 deco elements / 20 éléments de déco

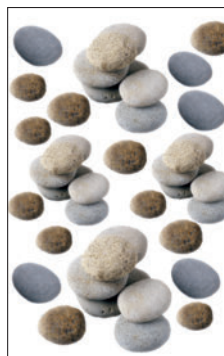

Elemente einzeln ablösbar
Individually detachable elements
Éléments détachables

1915 202 836
Natur

BLUBB 23 x 34 cm

26 Deco-Elemente / 26 deco elements / 26 éléments de déco



Elemente einzeln ablösbar
Individually detachable elements
Éléments détachables

1908 742 837
Wasserblau

BUDDHA 23 x 34 cm

12 Deco-Elemente / 12 deco elements / 12 éléments de déco



Elemente einzeln ablösbar
Individually detachable elements
Éléments détachables

1917 271 837
Taupe

BUTTERFLY 23 x 34 cm

21 Deco-Elemente / 21 deco elements / 21 éléments de déco



Elemente einzeln ablösbar
Individually detachable elements
Éléments détachables

1907 148 837
Multicolor

LAVASTONE 23 x 34 cm

18 Deco-Element / 18 deco elements / 18 éléments de déco



Elemente einzeln ablösbar
Individually detachable elements
Éléments détachables

1906 926 837
Schwarz

BAMBOO 23 x 68 cm

1 Deco-Element / 1 deco elemens / 1 élément de déco



1900 600 838
Grün

ORCHID 23 x 68 cm

1 Deco-Element / 1 deco elemens / 1 élément de déco



1903 100 838
Weiß



WC-SITZE

WC SEATS / ABATTANTS WC



DUROPLAST

WC-Sitze aus Duroplast

- Absenkautomatik
- bequeme Montage von oben
- zur Reinigung einfach abnehmbar
- passend für alle handelsüblichen WCs
- alle Metallteile aus rostfreiem Edelstahl

WC-Sitze aus Duroplast

- soft-close mechanism
- convenient assembly from above (likewise possible from below)
- easy to remove for cleaning
- suitable for all commercially available WCs
- all metal parts made of stainless steel

Abattants WC en duroplastique

- descente assistée pour abattant
- montage pratique par le haut (également possible par le bas)
- facilement amovible pour le nettoyage
- adapté pour tous les WC en usage dans le commerce
- toutes les pièces métalliques sont en acier affiné inoxydable

SOFT CLOSING

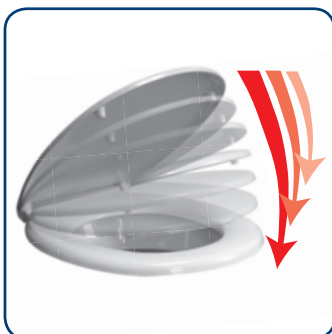

EASY INSTALL



EASY CLICK



EASY CLEAN



BLOSSOM 37 x 45 cm

Duroplast



1857 401 075
Nelke

BUBBLE 37 x 45 cm

Duroplast



1829 769 075
Marineblau

BUTTERFLIES 37 x 45 cm

Duroplast



1840 148 075
Multicolor

COSMO CAT 37 x 45 cm

Duroplast



1855 148 075
Multicolor

EULEN 37 x 45 cm

Duroplast



1837 271 075
Taupe

KOLIBRI 37 x 45 cm

Duroplast



1858 148 075
Multicolor

MARBLE 37 x 45 cm

Duroplast



1843 901 075
Anthrazit

NOVA 37 x 45 cm

Duroplast



1834 977 075
Platin

ROSALIE 37 x 45 cm

Duroplast



1850 148 075
Multicolor

ROSEMARIE 37 x 45 cm

Duroplast



1853 428 075
Bordeaux

SAFARI 37 x 45 cm

Duroplast



1856 682 075
Green

SANDSTRAND 37 x 45 cm

Duroplast



1826 222 075
Beige

SPORTSCHUH 37 x 45 cm

Duroplast



1828 700 075
Blau

UNI 37 x 45 cm

Duroplast



1823 100 075
Weiss

WAIKIKI 37 x 45 cm

Duroplast



1854 148 075
Multicolor

ZEN 37 x 45 cm

Duroplast



1825 148 075
Multicolor

ERSATZTEILE

Replacements / Pièces de rechange

WC Montage-Set, 6-teilig

Toilet fitting kit, 6 pieces
Kit de montage pour WC, 6 parties

1839 101 948
Chromfarbig

WC Deckelpuffer, 6-teilig

Toilet seat bumper, 6 pieces
Amortisseur pour abattant de WC, 6 parties

1813 100 948
Weiß



DUSCHVORHÄNGE

SHOWER CURTAINS / RIDEAUX DE DOUCHE

TEXTIL-DUSCHVORHÄNGE 100% Polyester SEITE 200-215

Textile shower curtains / Rideaux de douche en textile

Produkteigenschaften

- aus hochwertigem Polyestergewebe
- besonders haltbares und pflegeleichtes Material
- wasserabweisend
- verstärkte Lochleiste mit stabilen Ösen
- Beschwerungsband im unteren Saum

Product features

- high-quality textile fabric
- highly durable and easy-to-clean material
- water repellent
- reinforced perforated strip with sturdy eyelets
- weighted curtain ribbon in bottom belt

Caractéristiques du produit

- Textil de qualité supérieure
- particulièrement résistants et faciles à entretenir
- résistant à l'eau
- rebord renforcé à trous avec oeillets robustes
- cordon de lestage dans l'ourlet du bas

PEVA-DUSCHVORHÄNGE Ökoplast / PVC-frei SEITE 216-225

PEVA shower curtains Ecoplast / PVC-free / Rideaux de douche en PEVA Ecoplast / sans PVC

Produkteigenschaften

- PEVA / Öko-Plast aus PVC-freiem, umweltfreundlichem und recyclefähigem Material (Polyethylenvinylacetat)
- absolut wasserdicht
- verstärkte Lochleiste

Product features

- PVC-free material, recyclable and environmentally friendly
- completely waterproof
- reinforced perforated strip

Caractéristiques du produit

- matériau sans PVC, écologique et recyclable
- complètement étanche
- bande perforée enforcée

VINYL-DUSCHVORHÄNGE 100% Vinyl SEITE 226-227

Vinyl shower curtains 100% vinyl / Rideaux de douche en vinyle 100% vinyle

Produkteigenschaften

- aus kräftiger Vinyl-Folie
- besonders haltbares Material
- absolut wasserdicht

Product features

- strong vinyl film
- very durable material
- completely waterproof

Caractéristiques du produit

- film vinyle résistant
- matière très résistante
- complètement étanche



ANCHOR 200



BARCELONA 200



BATH 200



BATHROOM 201



BIRDIE 201

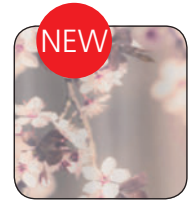

BLOSSOM 201



BUTTERFLIES 202



CANTON 202



CHECK 202



CARAVELLE 203

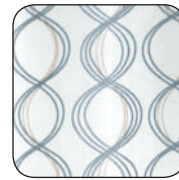

CLASSY 203



CORA 204



EULEN 204



EXOTIC 204



FLORENCE 205



FLORESTA 205



GEORGE 205



GRID 206



HOOK ON 206



JOLIE 207

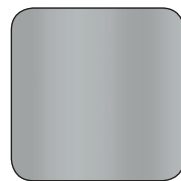

KITO 207



KOLIBRI 207



LEAF 208



LINEN 208



LOTUS 208



LUNA 209



MAGIC 209



MANDALAY 209



MARBLE 210

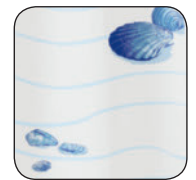

MIAMI 210



NOVA 210



RICA 211



RINGS 211



ROSALIE 211



ROSEMARIE 212



SAFARI 212



SANNA 212



SCARLETT 213



SCRIPT 213



SEASIDE 213



SELECT 214



SHEEP 214



STYLE 214

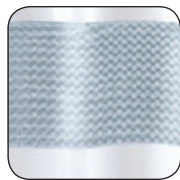

TWIN 215



WAIKIKI 215

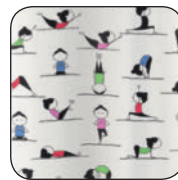

YOGI 215

ANCHOR

TEXTIL 100% Polyester

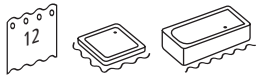

5900 ... 305
ca. 180 x 200 cm
29,90 CHF



5900 ... 238
ca. 120 x 200 cm

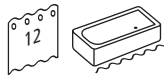

5900 ... 344
ca. 180 x 180 cm

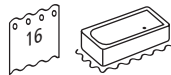

5900 ... 352
ca. 240 x 180 cm



789
Dunkelblau

BARCELONA

TEXTIL 100% Polyester



5188 ... 305
ca. 180 x 200 cm
29,90 CHF



5188 ... 238
ca. 120 x 200 cm

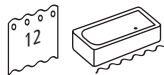

5188 ... 344
ca. 180 x 180 cm

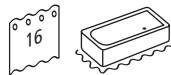

5188 ... 352
ca. 240 x 180 cm



602
Klee

BATH

TEXTIL 100% Polyester



DESIGNWELT
Framework



5959 ... 305
ca. 180 x 200 cm



185
Schwarz-Weiß



654
Mint



BATHROOM

TEXTIL 100% Polyester

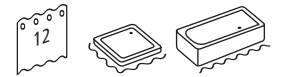

5219 ... 305
ca. 180 x 200 cm



100
Weiß



BIRDIE

TEXTIL 100% Polyester

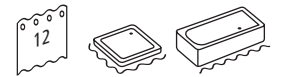

4985 ... 305
ca. 180 x 200 cm

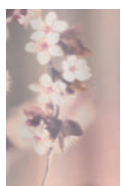

401
Nelke



BLOSSOM

TEXTIL 100% Polyester



5956 ... 305
ca. 180 x 200 cm

**FOTOREALISTISCHER
DRUCK**

Photorealistic print
Qualité satinée brillante



5956 ... 238
ca. 120 x 200 cm



5956 ... 344
ca. 180 x 180 cm

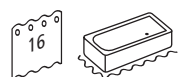

5956 ... 352
ca. 240 x 180 cm

BUTTERFLIES

TEXTIL 100% Polyester

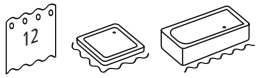

5282 ... 305
ca. 180 x 200 cm



5282 ... 238
ca. 120 x 200 cm

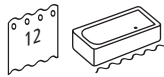

5282 ... 344
ca. 180 x 180 cm



5282 ... 352
ca. 240 x 180 cm



148
Multicolor

CANTON

TEXTIL 100% Polyester

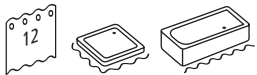

4994 ... 305
ca. 180 x 200 cm



114
Schneeweiß

CHECK

TEXTIL 100% Polyester



5270 ... 305
ca. 180 x 200 cm



271
Taupe



783
Mare

CARAVELLE

TEXTIL 100% Polyester

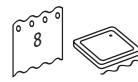

0308 ... 238
ca. 120 x 200 cm



0308 ... 305
ca. 180 x 200 cm

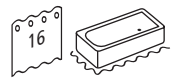

0308 ... 352
ca. 240 x 180 cm



Meterware Meter / Mètre



0308 ... 824
ca. 200 cm breit lfm.

0308 ... 833
1 lfm.

Sonderanfertigung
Special model / Modèle spécial
Custom dimensions
Dimensions souhaitées

CARAVELLE – der Duschvorhang mit Wunschgröße

Höhe nach Wunsch (mind. 100 cm)

- inkl. Ösenkante bzw. Gardinenband,
- Breite von mind. 60 cm bis max 200 cm

Breite nach Wunsch (mind. 60 cm)

- Höhe von mind. 100 cm bis max. 200 cm
- inkl. Ösenkante bzw. Gardinenband

Konfektionsarten zur Wahl:

- Gardinenfaltenband für Gardinenschiene oder
- Klarsichtige, hochfeste Kunststoffösen für Duschvorhangstange

Auftragsvermerk

Maße, Konfektionsart und Konfektionsstelle (Schmalseite oder Breitseite)

Lieferzeit:

ca. 4-5 Wochen. Rücktrittsrecht ausgeschlossen.

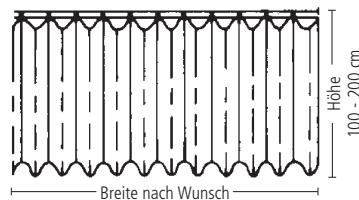
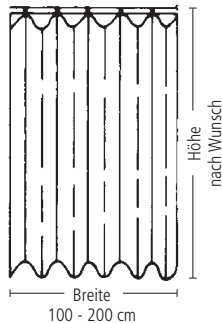

CARAVELLE - the shower curtain with the choice of size.

Length by request (min. 100 cm)

- incl. eyelet edge/curtain tape
- min. width 60 cm to max. 200 cm

Width by request (min. 60 cm)

- min. height of 100 cm to max. 200 cm
- incl. eyelet edge/curtain tape

Choice of fitting types:

- Folded curtain tape for curtain rail or
- Clear, high-strength, plastic eyelets for shower curtain rails.

Order comment:

Dimensions, fitting type and fitting position (narrow side or wide side).

Delivery period:

approx. 4-5 weeks, right of withdrawal prohibited.

CARAVELLE - le rideau de douche sur mesure

Hauteur au choix (au moins 100 cm)

- bordure à œillets ou ruban à rideau inclus
- largeur de 60 cm au moins à 200 cm max.

Largeur au choix (au moins 60 cm)

- hauteur de 100 cm au moins à 200 cm max.
- bordure à œillets ou ruban à rideau inclus

Modes de confection au choix:

- Ruban à rideau à plis pour rail à rideau ou
- Œillets en plastique transparent, très résistants pour tringles à rideau de douche.

Noter pour la commande:

dimensions, mode de confection et position de confection (côté étroit ou large).

Délai de livraison:

env. 4-5 semaines. Droit de rétractation exclu.



100
Weiß



CLASSY

TEXTIL 100% Polyester

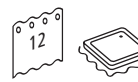

5911 ... 305
ca. 180 x 200 cm

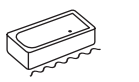

5911 ... 344
ca. 180 x 180 cm

PREMIUM
TEXTIL
GLANZENDES SATIN QUALITÄT

Glossy satin quality
Qualité satinée brillante

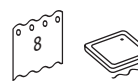

5911 ... 238
ca. 120 x 200 cm



5911 ... 352
ca. 240 x 180 cm

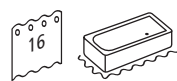

5911 ... 352
ca. 240 x 180 cm



100
Weiß



CORA

TEXTIL 100% Polyester

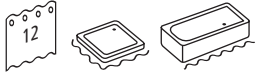

5946 ... 305
ca. 180 x 200 cm

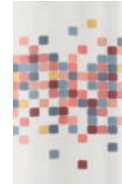

148
Multicolor

EULEN

TEXTIL 100% Polyester



5222 ... 305
ca. 180 x 200 cm



271
Taupe

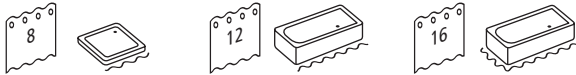

5222 ... 238
ca. 120 x 200 cm

5222 ... 344
ca. 180 x 180 cm

5222 ... 352
ca. 240 x 180 cm

EXOTIC

TEXTIL 100% Polyester



DESIGNWELT
Nude Peach



5964 ... 305
ca. 180 x 200 cm



226
Sandbeige

NEW



431
Rouge



FLORENCE

TEXTIL 100% Polyester



DESIGNWELT
J'adore



Glossy satin quality
Qualité satinée brillante

PREMIUM
TEXTIL

GLANZENDE SATIN QUALITÄT



5962 ... 305
ca. 180 x 200 cm



600
Grün



FLORESTA

TEXTIL 100% Polyester



5912 ... 305
ca. 180 x 200 cm



5912 ... 238
ca. 120 x 200 cm



5912 ... 344
ca. 180 x 180 cm

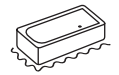

5912 ... 352
ca. 240 x 180 cm

NEW



271
Taupe



GEORGE

TEXTIL 100% Polyester



**FOTOREALISTISCHER
DRUCK**

Photorealistic print
Qualité satinée brillante



5958 ... 305
ca. 180 x 200 cm

GRID

TEXTIL 100% Polyester



Mit Goldeffekt
With gold effect
Avec effet or

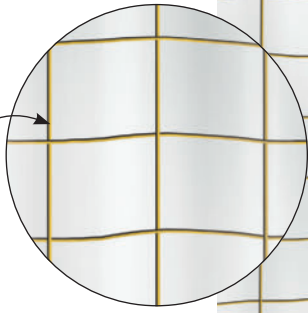

919
Schwarz-Gold



5914 ... 305
ca. 180 x 200 cm

HOOK ON

TEXTIL 100% Polyester



PREMIUM
TEXTIL

GLANZ REINHEIT QUALITÄT

Glossy satin quality
Qualité satinée brillante



Premium-Duschvorhang
mit integrierten Ringen

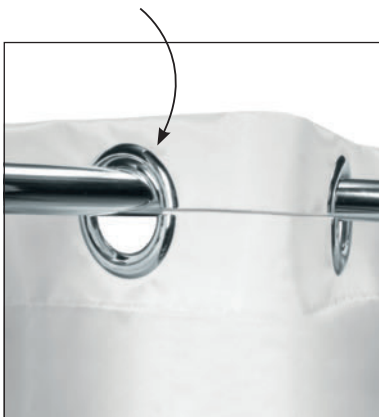

100
Weiß



5913 ... 305
ca. 180 x 200 cm

JOLIE

TEXTIL 100% Polyester



148
Multicolor

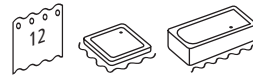

5194 ... 305
ca. 180 x 200 cm

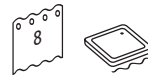

5194 ... 238
ca. 120 x 200 cm



5194 ... 344
ca. 180 x 180 cm

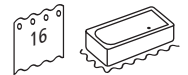

5194 ... 352
ca. 240 x 180 cm

KITO

TEXTIL 100% Polyester



4937 ... 305
ca. 180 x 200 cm



4937 ... 238
ca. 120 x 200 cm



4937 ... 352
ca. 240 x 180 cm



114 Schneeweiß



202 Natur



723 Azur



905 Schiefer



913 Nebel

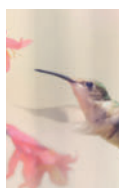

148
Multicolor



KOLIBRI

TEXTIL 100% Polyester



**FOTOREALISTISCHER
DRUCK**

Photorealistic print
Qualité satinée brillante



5957 ... 305
ca. 180 x 200 cm

LEAF

TEXTIL 100% Polyester



DESIGNWELT
Green Infusion

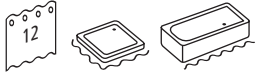

5961 ... 305
ca. 180 x 200 cm



685
Maledivia

LINEN

TEXTIL 100% Polyester



5916 ... 305
ca. 180 x 200 cm



291
Bast

LOTUS

TEXTIL 100% Polyester



5944 ... 305
ca. 180 x 200 cm



685
Maledivia



185
Schwarz Weiß



LUNA

TEXTIL 100% Polyester



5124 ... 305
ca. 180 x 200 cm



148
Multicolor



MAGIC

TEXTIL 100% Polyester



5963 ... 305
ca. 180 x 200 cm

DESIGNWELT
Magical Moments



5963 ... 238
ca. 120 x 200 cm



5963 ... 344
ca. 180 x 180 cm

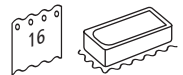

5963 ... 352
ca. 240 x 180 cm



148
Multicolor



MANDALAY

TEXTIL 100% Polyester



5943 ... 305
ca. 180 x 200 cm

MARBLE

TEXTIL 100% Polyester



5283 ... 305
ca. 180 x 200 cm



5283 ... 238
ca. 120 x 200 cm

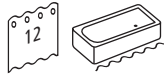

5283 ... 344
ca. 180 x 180 cm



5283 ... 352
ca. 240 x 180 cm



901
Anthrazit

MIAMI

TEXTIL 100% Polyester



5163 ... 305
ca. 180 x 200 cm



5163 ... 238
ca. 120 x 200 cm

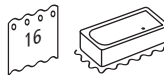

5163 ... 352
ca. 240 x 180 cm

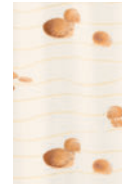

216
Beige



700
Blau

NOVA

TEXTIL 100% Polyester



5274 ... 305
ca. 180 x 200 cm



407
Old Rose



977
Platin

NEW



114
Schneeweiß



202
Natur



Der Duschvorhang RICA ist ein umweltfreundliches Naturprodukt:

- aus recyceltem Material
- mit rostfreien Metallösen

The RICA shower curtain is an environmentally friendly natural product:

- from recycled material
- with stainless metal eyelets

Le rideau de douche RICA est un produit naturel respectueux de l'environnement :

- fabriqués à partir de matériaux recyclés
- avec oeillets en métal inoxydable

TEXTIL 100% Polyester



5965 ... 305
ca. 180 x 200 cm

RINGS

TEXTIL 100% Polyester



185
Schwarz Weiß



5281 ... 305
ca. 180 x 200 cm

ROSALIE

TEXTIL 100% Polyester



148
Multicolor



5910 ... 305
ca. 180 x 200 cm

**FOTOREALISTISCHER
DRUCK**

Photorealistic print
Qualité satinée brillante



5910 ... 238
ca. 120 x 200 cm



5910 ... 344
ca. 180 x 180 cm



5910 ... 352
ca. 240 x 180 cm

ROSEMARIE

TEXTIL 100% Polyester



FOTOREALISTISCHER
DRUCK

Photorealistic print
Qualité satinée brillante

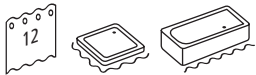

5940 ... 305
ca. 180 x 200 cm



428
Bordeaux

SAFARI

TEXTIL 100% Polyester



Das passt dazu:

That fits: / Ça correspond:



5955 ... 305
ca. 180 x 200 cm

SAFARI
WC-Deckel mit passendem Motiv
WC lid with fitting image
Couvercle de WC avec image appropriée
> Seite 196 / page 196



682
Green

SANNA

TEXTIL 100% Polyester

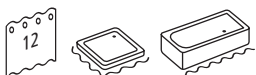

4935 ... 305
ca. 180 x 200 cm



4935 ... 238
ca. 120 x 200 cm

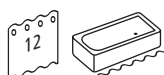

4935 ... 344
ca. 180 x 180 cm



4935 ... 352
ca. 240 x 180 cm



100
Weiß



683
Smaragd



SCARLETT

TEXTIL 100% Polyester

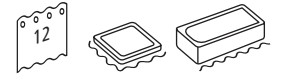

5915 ... 305
ca. 180 x 200 cm



148
Multicolor



SCRIPT

TEXTIL 100% Polyester



5171 ... 305
ca. 180 x 200 cm



733
Krokusblau



SEASIDE

TEXTIL 100% Polyester



0856 ... 305
ca. 180 x 200 cm

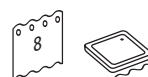

0856 ... 238
ca. 120 x 200 cm



0856 ... 344
ca. 180 x 180 cm

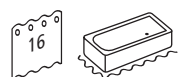

0856 ... 352
ca. 240 x 180 cm

SELECT

TEXTIL 100% Polyester



5255 ... 305
ca. 180 x 200 cm



148
Multicolor

SHEEP

TEXTIL 100% Polyester



5130 ... 305
ca. 180 x 200 cm



148
Multicolor

STYLE

TEXTIL 100% Polyester



5939 ... 305
ca. 180 x 200 cm



146
Silbergrau



114
Schneeweiß



TWIN

TEXTIL 100% Polyester



5299 ... 305
ca. 180 x 200 cm



148
Multicolor



WAIKIKI

TEXTIL 100% Polyester



FOTOREALISTISCHER
DRUCK

Photorealistic print
Qualité satinée brillante



5941 ... 305
ca. 180 x 200 cm

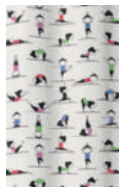

148
Multicolor



YOGI

TEXTIL 100% Polyester



5923 ... 305
ca. 180 x 200 cm

ÜBERSICHT SEITE 216-225

PEVA-Duschvorhänge

BAMBÚ 216	BLOOM 217	BUBBLE 217	CASCADA 217	CHARLIE 218	CLARO 218
CLIPPER 218	CONFETTI 219	DOLPHIN 219	FREDDY 219	HELLO 220	MALEDIVEN 220
NEW BEACH 220	NOA 221	PENGUIN 221	POCKET 221	RAY 222	REISELUST 222
SEALIFE 222	SHELL 223	SOAPY 223	SONNY 223	SPARKLE 224	UNO 224
VIVA 224	WINGS 225	ZACK 225	ZORA 225		

BAMBÚ

ÖKOPLAST 100% PEVA PVC-frei



5249 ... 305
ca. 180 x 200 cm



625
Maigrün

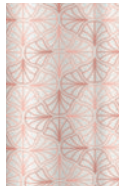

398
Pearl



BLOOM

ÖKOPLAST 100% PEVA **PVC-frei**



5945 ... 305
ca. 180 x 200 cm



769
Marineblau



BUBBLE

ÖKOPLAST 100% PEVA **PVC-frei**



5192 ... 305
ca. 180 x 200 cm



683
Smaragd



CASCADA

ÖKOPLAST 100% PEVA **PVC-frei**



5919 ... 305
ca. 180 x 200 cm

CHARLIE

ÖKOPLAST 100% PEVA PVC-frei



5178 ... 305
ca. 180 x 200 cm

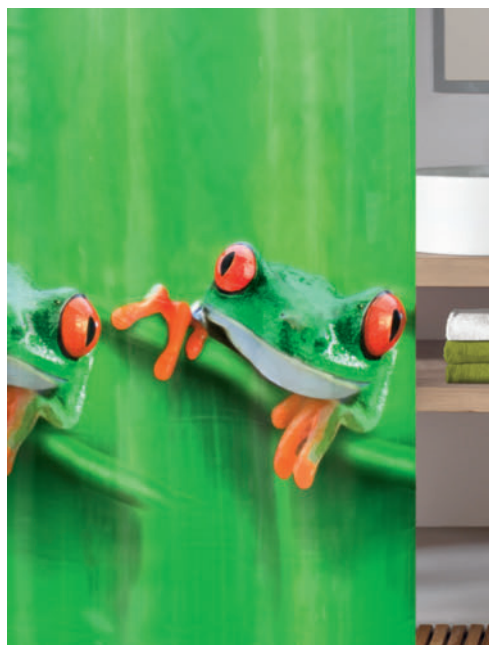

625
Maigrün

CLARO

ÖKOPLAST 100% PEVA PVC-frei



5920 ... 305
ca. 180 x 200 cm



116
Clear

CLIPPER

ÖKOPLAST 100% PEVA PVC-frei



5209 ... 238
ca. 120 x 200 cm



5209 ... 305
ca. 180 x 200 cm



723
Azur



901
Anthrazit



148
Multicolor



CONFETTI

ÖKOPLAST 100% PEVA PVC-frei

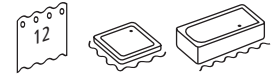

5937 ... 305
ca. 180 x 200 cm



148
Multicolor



DOLPHIN

ÖKOPLAST 100% PEVA PVC-frei



5201 ... 305
ca. 180 x 200 cm



700
Blau



FREDDY

ÖKOPLAST 100% PEVA PVC-frei



5162 ... 305
ca. 180 x 200 cm

HELLO

ÖKOPLAST 100% PEVA PVC-frei

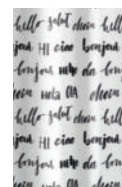

185
Schwarz Weiß



5905 ... 305
ca. 180 x 200 cm

MALEDIVEN

ÖKOPLAST 100% PEVA PVC-frei



148
Multicolor



5202 ... 305
ca. 180 x 200 cm

NEW BEACH

ÖKOPLAST 100% PEVA PVC-frei



148
Multicolor



4959 ... 305
ca. 180 x 200 cm

NOA

ÖKOPLAST 100% PEVA **PVC-frei**



100
Weiß



5193 ... 305
ca. 180 x 200 cm

PENGUIN

ÖKOPLAST 100% PEVA **PVC-frei**



700
Blau



5922 ... 305
ca. 180 x 200 cm

POCKET

ÖKOPLAST 100% PEVA **PVC-frei**



116
Clear



Transparenter Duschvorhang
inklusive 4 Taschen mit Touchfunktion.
Geeignet für Smartphone oder Tablet.

Transparent shower curtain with 4 pockets with
touch function. Suitable for smartphone or tablet.
Rideau de douche transparent avec 4 poches
à fonction tactile. Convient pour smartphone
ou tablette.



5936 ... 305
ca. 180 x 200 cm

RAY

ÖKOPLAST 100% PEVA PVC-frei



5917 ... 305
ca. 180 x 200 cm



452
Burgund



789
Dunkelblau

REISELUST

ÖKOPLAST 100% PEVA PVC-frei

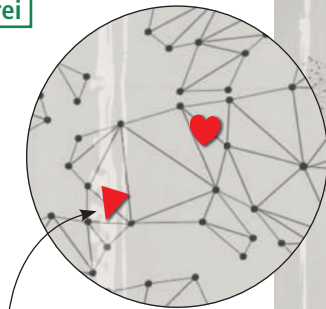

Inklusive wasserfesten Aufklebern zum Markieren der persönlichen Lieblingsorte

Including waterproof stickers for marking your personal favourite places
Y compris des autocollants imperméables pour marquer de vos lieux préférés



5960 ... 305
ca. 180 x 200 cm



926
Schwarz

SEALIFE

ÖKOPLAST 100% PEVA PVC-frei



4990 ... 305
ca. 180 x 200 cm



700
Blau



720
Blau



SHELL

ÖKOPLAST 100% PEVA **PVC-frei**



5938 ... 305
ca. 180 x 200 cm



742
Wasserblau



SOAPY

ÖKOPLAST 100% PEVA **PVC-frei**



5921 ... 305
ca. 180 x 200 cm



580 Sun



605 Alge



721 Blue



808 Violett



901 Anthrazit



SONNY

ÖKOPLAST 100% PEVA **PVC-frei**



4956 ... 305
ca. 180 x 200 cm

SPARKLE

ÖKOPLAST 100% PEVA PVC-frei



5947 ... 305
ca. 180 x 200 cm



100
Weiß

UNO

ETHYLENVINYLCETAT PVC-frei



5210 ... 305
ca. 180 x 200 cm



208
Ecreu

VIVA

ÖKOPLAST 100% PEVA PVC-frei



4997 ... 305
ca. 180 x 200 cm



114
Schneeweiß



442
Flamingo



WINGS

ÖKOPLAST 100% PEVA **PVC-frei**



Die gedruckten Flügel sorgen für ein echtes Highlight im Badezimmer.

The printed wings provide a real highlight in the bathroom.
Les ailes imprimées attirent tous les regards dans votre salle de bains.



5942 ... 305
ca. 180 x 200 cm



905
Schiefer



ZACK

ÖKOPLAST 100% PEVA **PVC-frei**



DESIGNWELT
Framework



5954 ... 238
ca. 120 x 200 cm



5954 ... 305
ca. 180 x 200 cm



100
Weiß



ZORA

ÖKOPLAST 100% PEVA **PVC-frei**



5918 ... 305
ca. 180 x 200 cm

ÜBERSICHT SEITE 226-227

Vinyl-Duschvorhänge



CRISTAL

226



GRAFICO

226

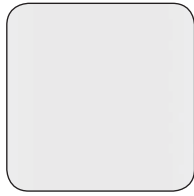

PHÖNIX

227

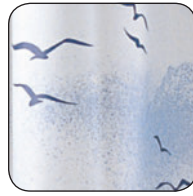

SKY

227

CRISTAL

100% VINYL



5174 ... 305
ca. 180 x 200 cm



116
Clear

GRAFICO

100% VINYL



4939 ... 305
ca. 180 x 200 cm



901
Anthrazit



100
Weiß



PHÖNIX

100% VINYL



4945 ... 238
ca. 120 x 200 cm

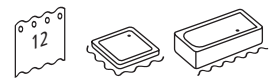

4945 ... 305
ca. 180 x 200 cm

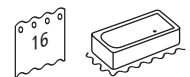

4945 ... 352
ca. 240 x 180 cm



739
Polarblau



SKY

100% VINYL



0826 ... 305
ca. 180 x 200 cm



ZUBEHÖR + DUSCHROLLOS

FITTINGS + SHOWER BLINDS
GARNITURE + STORES DE DOUCHE

Das praktische Duschvorhang-Zubehör von Kleine Wolke ist einfach zu montieren, besonders langlebig, hygienisch, pflegeleicht und universell einsetzbar. Durch die einfache Montage lassen sich auch die individuellsten Gestaltungsideen schnell und unkompliziert verwirklichen.

The practical shower curtain accessories in the Consumer Collection are attractively designed, hygienic, easy-care and universally implementable. The simple installation helps to realise the most individual design ideas, quickly and straight-forwardly.

Les accessoires pour rideau de douche pratiques de la Collection Consumer sont attrayants, hygiéniques, faciles à entretenir et universels. Leur montage simple permet de mettre en oeuvre rapidement ses propres idées de décoration.



UNIVERSALSTANGE \varnothing 25 mm



100 Weiß



101 Chromfarbig



Verkürzung durch
Absägen möglich

Shortening possible
by sawing off
Raccourcissement possible
par coupe à la scie



Deckenhalterung empfohlen
Ceiling mount kit recommended.
Kit de montage plafond recommandé.

für Dusche und Badewanne

Universal rod \varnothing 25 mm
for shower and bath

Barre universelle \varnothing 25 mm
pour douche et baignoire

Montagebeispiele

Installation examples / Exemples d'installation

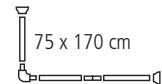

0345 ... 001

WINKELSTANGE \varnothing 25 mm



100 Weiß



101 Chromfarbig



Verkürzung durch
Absägen möglich

Shortening possible
by sawing off
Raccourcissement possible
par coupe à la scie



Deckenhalterung empfohlen
Ceiling mount kit recommended.
Kit de montage plafond recommandé.

für Duschen

Angular shower curtain rod
 \varnothing 25 mm

Barre coudée pour rideau de
douche \varnothing 25 mm

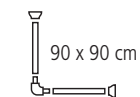

0348 ... 001

DECKENHALTERUNG \varnothing 25 mm



100 Weiß



101 Chromfarbig



Verkürzung durch
Absägen möglich

Shortening possible
by sawing off
Raccourcissement possible
par coupe à la scie

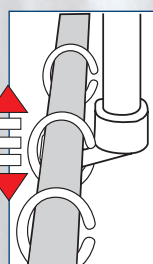
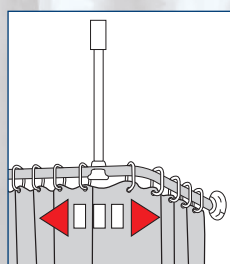
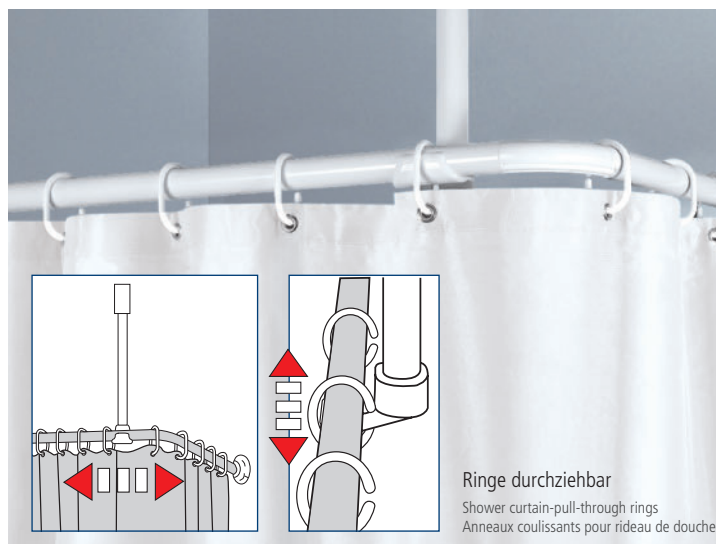

Ringe durchziehbar

Shower curtain-pull-through rings
Anneaux coulissants pour rideau de douche

für DV-Stangen mit \varnothing 25 mm

Suspension rod for fixing
to ceiling, \varnothing 25 mm

for shower curtain rods with \varnothing 25 mm

Suspension à barre au
plafond, \varnothing 25 mm

pour tringles à rideaux de
douche avec \varnothing 25 mm



3303 ... 000

FEDERSTANGE Ø 21 mm SPRING ROD / BARRE EXTENSIBLE

Auf **gewünschte Breite + 3 cm** ausziehen und einspannen

Simply pullout to **desired length + 3 cm** and clamp into position.

Tirer à la **largeur adéquate + 3 cm**, puis comprimer et relâcher à l'endroit choisi.



Verkürzung durch Absägen möglich auf eine Länge von 20cm.

Shortening possible by sawing off to a length of 20 cm.
Raccourcissement possible par coupe à la scie à une longueur de 20 cm.

0361 ... 000



75 - 125 cm

0362 ... 000



125 - 220 cm



100 Weiß



101 Chromfarbig



926 Schwarz



Hinweis zur Montage

Alle Federstangen müssen vor dem Einspannen immer auf die **gewünschte Breite + 3 cm** ausgezogen werden, damit die Stange auf Spannung gebracht wird.

Installation advice: Before being clamped, all spring rods must always be pulled out to the **desired width + 3 cm** so that the rod is tensioned.

Remarque de montage : Avant de fixer l'article, toujours déplier toutes les barres à ressorts à la **largeur souhaitée + 3 cm**, pour que la barre se trouve sous tension.

FEDERSTANGE mit Struktur, Ø 21 mm

Spring rod with structure

Barre extensible avec structure



Verkürzung durch Absägen möglich auf eine Länge von 20cm.

Shortening possible by sawing off to a length of 20 cm.
Raccourcissement possible par coupe à la scie à une longueur de 20 cm.

3343 ... 014



75 - 125 cm

3343 ... 034



125 - 220 cm



101 Chromfarbig

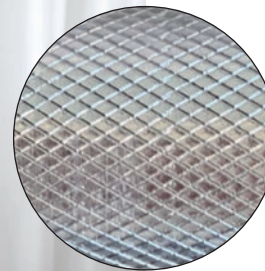

Mit geriffelter Oberflächen-Struktur

With ribbed surface structure
Avec nervures structure de la surface

Federstange zu weit ausgezogen? Kein Problem! Mit dieser Anleitung wird die Stange schnell wieder einsatzbereit:

Spring rod extended too far? No problem! These instructions will help you get the rod quickly ready for use again:

Vous avez trop étiré la barre à ressorts ? Pas de problème ! Ces instructions vous permettront rapidement de remettre votre barre en état de marche :

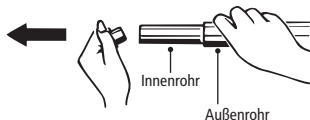

1. Stange komplett auseinanderbauen. Dazu die **Endstücke abnehmen** und das weiße **Übergangsstück abziehen**. Die Stange besteht aus einem Innenrohr (kleinerer Durchmesser mit Feder) und dem Außenrohr.

1. Disassemble the rod completely. To do this, **remove the end pieces** and the **white adapter piece**. The rod consists of an inner tube (smaller diameter with spring) and the outer tube.

1. Démontez totalement la barre. À cet effet, **retirer les embouts et enlever la pièce intermédiaire blanche**. La barre se compose d'un tube intérieur (avec le plus petit diamètre et un ressort) et d'un tube extérieur.



2. Das Innenrohr komplett aus dem Außenrohr ziehen.

2. Completely **remove** the inner tube **from the outer tube**.

2. Retirer complètement le tube intérieur **du tube extérieur**.



3. Das Innenrohr mit der Seite **ohne Feder** wieder in das Außenrohr stecken und bis zur anderen Seite **durchschieben/-ziehen**. Dann kann das Übergangsstück aufgeschoben und die Endstücke wieder eingesetzt werden.

3. Put the inner tube with the side **without the spring** back into the outer tube and push/pull it through to the other side. The adapter piece can then be pushed on and the end pieces reattached.

3. Emboîter de nouveau le tube intérieur avec le côté **dénué de ressort** dans le tube extérieur, et **le pousser/le faire passer au travers** jusqu'à l'autre côté. La pièce intérieure peut alors être décalée, et les embouts peuvent être remis en place.



4. Die Stange ist nun wieder funktionsfähig und lässt sich auf die gewünschte Länge ausziehen.

4. The rod is now ready for use again and can be extended to the desired length.

4. Désormais, la barre est de nouveau fonctionnelle, et peut se rallonger à la longueur souhaitée.

FEDERSTANGE Ø 25 mm



100 Weiß



101 Chromfarbig



Auf **gewünschte Breite + 3 cm** ausziehen und einspannen
Simply pullout to **desired length + 3 cm** and clamp into position.
Tirer à la **largeur adéquate + 3 cm**, puis comprimer et relâcher à l'endroit choisi.

0347 ... 001



75 - 125 cm

0346 ... 001



125 - 220 cm

3302 ... 000



130 - 250 cm



Verkürzung durch Absägen möglich auf eine Länge von 20cm.

Shortening possible by sawing off to a length of 20 cm.
Raccourcissement possible par coupe à la scie à une longueur de 20 cm.

ERGÄNZUNGSTEILE Ø 25 mm

für DV-Stangen Ø 25 mm / for shower curtain rod Ø 25 mm / pour barre à rideau de douche Ø 25 mm



100 Weiß



ENDSTÜCK

End fitting / Extrémité

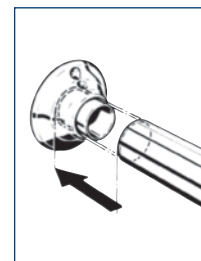

Länge 6 cm
length 6 cm
longueur 6 cm

3307 ... 000



100 Weiß



SCHRÄGWANDHALTER

Zur Befestigung von Duschgestängen an schrägen Wänden

Mounting bracket for sloping ceiling
Holding fit for shower curtain rods on oblique walls.

Support mural transversal
Support pour l'installation de barres sur murs obliques.

0395 ... 000

RUNDSTANGE \varnothing 25 mm

für Duschwannen

Round pole for shower
Tige arrondie pour douche



90 x 90 cm
oder Zwischenmaße
80-90 x 80-90 cm

3301 ... 000



101 Chromfarbig



Verkürzung durch
Absägen möglich
Shortening possible
by sawing off
Raccourcissement possible
par coupe à la scie

DUSCHSTANGE BOGEN \varnothing 25 mm

Duschstange mit Teleskop-System

Telescopic shower curtain rod
Barre de Douche avec système télescopique

101 Chromfarbig

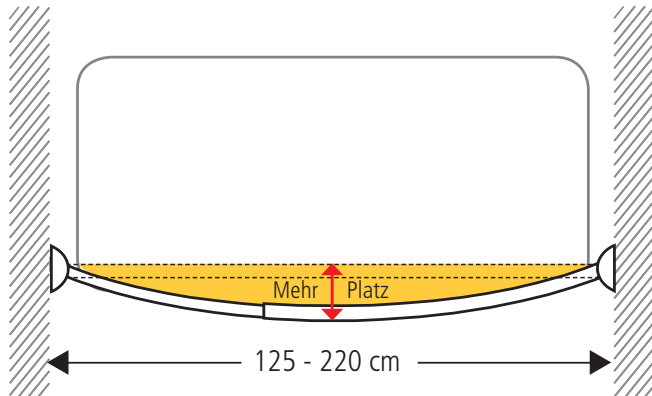

3334 ... 000
125 - 220 cm



SEILSYSTEM ca. 500 cm



Seilsystem mit Gelenk

Cable system with joint
Ensemble de cordes avec articulation

101 Chromfarbig

3308 ... 000

S-HAKEN 12 Stück



S-Haken für Seilsystem

S-Hook for cord system
Crochet en S pour système de corde

101 Chromfarbig

3309 ... 000 12 Stück / unit / unités

DUSCHVORHANG ZUBEHÖR

Fittings for shower curtains / Garniture pour rideaux de douche



000 Glasklar
100 Weiß
657 Tanne



766 Türkis
789 Dunkelblau
926 Schwarz



DUSCHVORHANG-RINGE

Shower curtain rings
Anneaux pour rideau de douche

0268 ... 000
12 Stück / unit / unités



124
Silber



DV-RINGE SILBER

Shower curtain rings, silver
Anneaux d'argent pour rideau de douche

3331 ... 000
12 Stück / unit / unités



117
Chrom



DV-RINGE BOCCIA

Shower curtain rings
Anneaux pour rideau de douche

3332 ... 000
12 Stück / unit / unités



000 Glasklar
100 Weiß



Zum Befestigen des Duschvorhangs an der Wand bzw. Duschkabine

To fix the shower curtain on the wall or shower cubicle
Fixer le rideau de douche au mur ou cabine de douche

KLAMMERN

Shower curtain clips
Pinces à rideau de douche

0279 ... 000
2 Stück / unit / unités

NEW

SCHIENENSYSTEM MIT GLEITERN für Dusche und Badewanne

RAIL SYSTEM WITH SLIDERS for shower and bath
SYSTÈME DE RAIL AVEC ROULETTES pour douche et baignoire

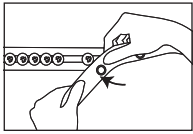

Keine Ringe erforderlich! Einfach den Duschvorhang an die integrierten Gleiter anknüpfen. Fertig!
Besonders geeignet für alle textilen Duschvorhänge von Kleine Wolke.

No rings necessary! All you have to do is attach the shower curtain to the integrated sliders. Finished!
Particularly suitable for all textile shower curtains by Kleine Wolke.

Pas besoin d'anneaux! Il suffit de les boutonner aux roulettes intégrées.
Et c'est fini! **Convient en particulier pour tous les rideaux de douche textiles de Kleine Wolke.**

WINKELSCHIENE

Shower curtain rail
Triangle pour rideau de douche

Montagebeispiele:

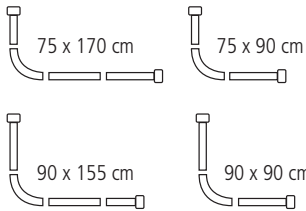

3336 100 019
75 x 170 cm



Verkürzung durch Absägen möglich
Shortening possible by sawing off
Raccourcissement possible par coupe à la scie

inkl. 16 Gleiter
incl. 16 gliders
incl. 16 glisseurs

100 Weiß



Deckenhalterung empfohlen
Ceiling mount kit recommended.
Kit de montage plafond recommandé.

FEDERSCHIENE

Rail. Adjustable by inside spring.
Triangle a ressort

Nur auf gewünschte Breite ausziehen und einspannen.

Simply pullout to desired length and clamp into position.
Trier a la largeur adequate, puis comprimer et relacher a l'endroit choisi.



3335 100 014
75-125 cm

3335 100 034
125-220 cm



Verkürzung durch Absägen möglich
Shortening possible by sawing off
Raccourcissement possible par coupe à la scie

inkl. 12 Gleiter
incl. 12 gliders
incl. 12 glisseurs

100 Weiß



Siehe Montagehinweis auf Seite 230
See mounting instructions on page 230
Voir les instructions de montage à la page 230

DECKENHALTERUNG

für Duschvorhangschienen

Suspension rod for fixing to ceiling
Suspension a barre au plafond



Verkürzung durch Absägen möglich
Shortening possible by sawing off
Raccourcissement possible par coupe à la scie

3337 100 024
60 cm

100 Weiß



ERSATZGLEITER

Additional gliders
Glisseurs supplémentaires



3338 100 970
5 Stück / 5 pieces / 5 pièces

100 Weiß

BIG SPIDER



100 Weiß



Duschvorhang-Spinne mit 12 Armen

„Spider“ shower curtain frame with 12 arms
Support „araignée“ pour rideau de douche avec 12 bras

Passt für jeden Duschvorhang (180 x 200 cm) von Kleine Wolke

Fits any Kleine Wolke shower curtain (180 x 200 cm)

Compatible avec tous les rideaux de douche Kleine Wolke (180 x 200 cm)

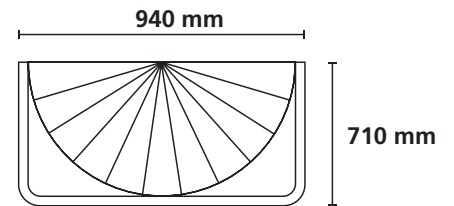

3325 ... 000

SPIDER



000 (mit DV Glasklar)



100 (mit DV Weiß)



Praktische Duschvorhang-Kabine mit Vinyl-Duschvorhang 200 x 170 cm.

Useful shower curtain cubicle with vinyl curtain 200 x 170 cm.

Cabine pliante utile à rideau avec PVC-rideau de douche 200 x 170 cm.

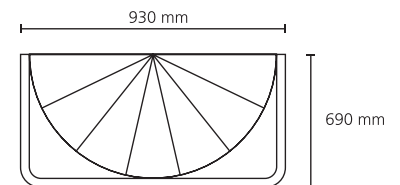

0382 ... 000
DV-Set

Das passt dazu: That fits: / Ça correspond:

SHOWER CURTAIN
RIDEAU DE DOUCHE



100 Weiß

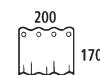

5101 ... 303

100% VINYL



wasserdicht
waterproof
étanche à l'eau

DUSCHROLLO INDIVIDUELL



Shower roller blind Store de douche

8 modische Duschrollo-Designs aus 100% Vinyl

- Abrollkordel links oder rechts montierbar
- Designs flexibel austauschbar
- einfache Montage
- platzsparend
- magnetisches Beschwerungsband im Saum
- offene Kassette verhindert Schimmelbildung

8 trendy shower blind designs, 100% Vinyl

- side pull installable left or right side
- designs flexibly interchangeable
- easy installation
- space-saving
- magnetic strip in the hem
- open cartridge prevents mould formation

8 décors tendance de store de douche, 100% Vinyl

- cordelette montable à gauche ou à droite
- designs échangeables
- montage facile
- peu encombrant
- rubant magnétique alourdissant dans l'ourlet
- caisson ouvert défavorable à la formation de moisissure

So funktioniert's: That's how it works: / Ça fonctionne comme ça:

A Leerkassette
Empty cartridge
Le caisson

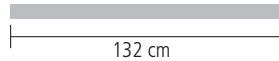

3320 ... 746
Leerkassette



100 Weiß

+

B Duschrollo
Shower roller blind
Store de douche

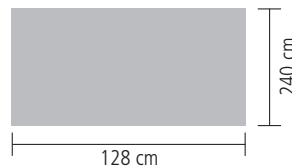

3321 ... 747
Duschrollo

Alle Designs
all designs / tous les modèles

100% VINYL



108 Milky
Duschrollo Design 1



100 Weiß
Duschrollo Design 3



213 Perlmutter
Duschrollo Design 4



110 Grau
Duschrollo Design 6

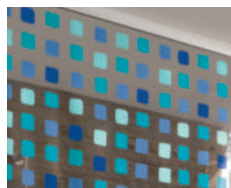

721 Blue
Duschrollo Design 8



351 Kupfer
Duschrollo Design 10

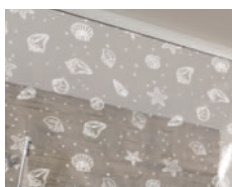

114 Schneeweiß
Duschrollo Design 11



109 Weiß
Duschrollo Design 12

ECKDUSCHROLLO

Corner shower roller blind
Store de douche enangle

Komplett mit 2 Kassetten und passenden Duschrollo

- in 3 modischen Designs verfügbar
- Eckstück links oder rechts montierbar
- einfache Montage
- platzsparend
- magnetisches Beschwerungsband im Saum
- offene Kassette verhindert Schimmelbildung

Complete with 2 cartridges and matching shower blinds

- 3 trendy designs available
- corner piece installable left or right side
- easy installation
- space-saving
- magnetic strip in the hem
- open cartridge prevents mould formation

Complet avec 2 caissons et les stores assortis

- trois décors disponibles
- angle montable à gauche ou à droite
- montage facile
- peu encombrant
- ruban magnétique alourdissant dans l'ourlet
- caisson ouvert défavorable à la formation de moisissure



Alle Designs
all designs / tous les modèles

100% VINYL

3319 ... 745
Eckduschrullo

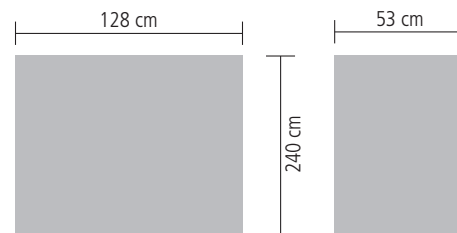
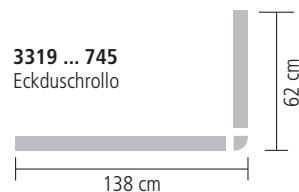

108 Milky
Eckduschrullo Design 1



100 Weiß
Eckduschrullo Design 3



110 Grau
Eckduschrullo Design 6

SCHMALES DUSCHROLLO

Slim shower roller blind
Store de douche étroit

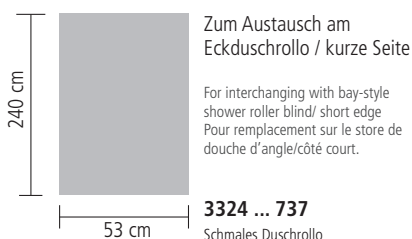

108 Milky
Schmales Duschrullo
Design 1



100 Weiß
Schmales Duschrullo
Design 3

Alle Designs
all designs / tous les modèles

100% VINYL



110 Grau
Schmales Duschrullo
Design 6

SICHERHEITSEINLAGEN

SAFETY INSERTS

TAPIS ANTI-DÉRAPANTS

Sicherheitseinlagen

- ausgewogenes Verhältnis zwischen Komfortanspruch und Sicherheitsaspekten
- qualitativ hochwertiges PVC oder PVC-freies Material
- Saugnäpfe sorgen für die erforderliche, einwandfreie Haftung auf dem Wanneboden
- moderne Uni-Modelle sowie eine große Auswahl bedruckter Einlagen

Safety inserts

- perfect balance between comfort requirements and safety aspects
- high-quality PVC or PVC-free material
- suction cups ensure the necessary, perfect adhesion to the bottom of the tub
- modern plain models as well as a large selection of printed inserts

Tapis anti-dérapants

- un rapport équilibré entre le confort et la sécurité
- en PVC ou matériau sans PVC de qualité supérieure
- Les ventouses garantissent l'adhérence obligatoire et pratique au fond de la baignoire
- modèles unis modernes ainsi qu'une large sélection d'emplacements imprimés



ÜBERSICHT SEITE 240 - 245

Content page 240 - 245 / Contenu page 240 - 245



AROSA 240



AROSA RUND 240



CASABLANCA 240



FORMOSA 241



HONEY 241

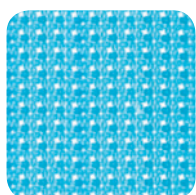

IVY 242



JAVA PLUS 242

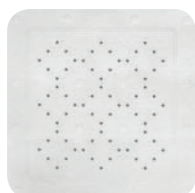

JOY 242



MOBY 243



RUBY 243



SAMOA PLUS 244



SERENE 244



SIGN 245



WELLNESS 245

ÜBERSICHT SEITE 246 - 251

Content page 246 - 251 / Contenu page 246 - 251



ANCHOR 246



BEACH 246



BUBBLE 246

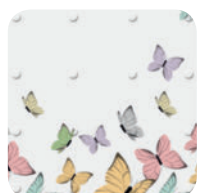

BUTTERFLIES 247

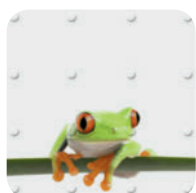

CHARLIE 247



EULE 247

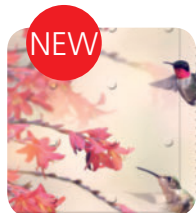

KOLIBRI 248

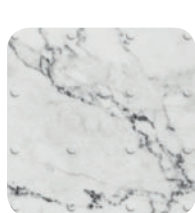

MARBLE 248



ROSALIE 248



ROSEMARIE 249



SAFARI 249



STARS 249



STEPSTONE 250



WAIKIKI 250



ZEN 250



PILLOW 251



ANTI-RUTSCH STICKER 251

MINIS / DEKORE SEITE 252 - 253

Minis / Deco-Accessories 252 - 253

AROSA

PVC



0221 ... 008
ca. 32 x 22 cm



0221 ... 002
ca. 55 x 55 cm



0221 ... 001
ca. 36 x 92 cm

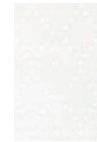

100
Weiß



201
Beige



226
Sandbeige



720
Blau

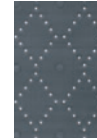

901
Anthrazit



923
Möwe

AROSA RUND

PVC



0221 ... 110
ca. Ø 55 cm



100
Weiß



720
Blau

CASABLANCA

PVC



4113 ... 051
ca. 75 x 75 cm



100
Weiß



Ideal geeignet für
bodengleiche Duschen
Ideal for level showers
Idéal pour douches à niveau

FORMOSA



Kautschuk



FORMOSA ist ein umweltfreundliches Naturprodukt

FORMOSA is an environmentally friendly natural product.
FORMOSA est un respectueux de l'environnement produit naturel



100 Weiß
746 Stahlblau
901 Anthrazit

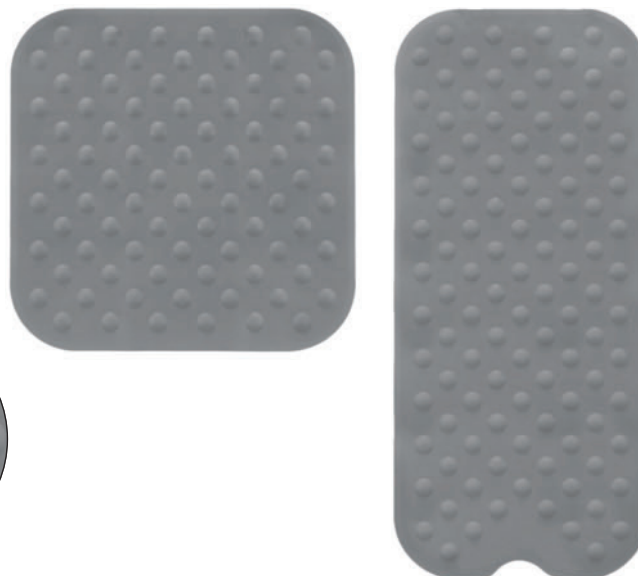

Modernes Design und hohe Rutschfestigkeit durch größere Noppen

Modern design and high quality slip resistance due to greater burls
Design moderne et haute qualité résistance au glissement grâce à une plus grande ronces

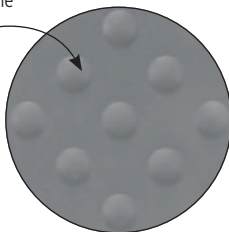

4100 ... 118
ca. 53 x 53 cm



4100 ... 107
ca. 40 x 90 cm

HONEY

PVC



116
Clear



Transparente Sicherheits-einlage in moderner Optik

Transparent safety insert in a modern look
Tapis anti-dérapant transparent dans un look moderne

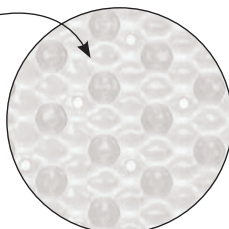

5352 ... 002
ca. 55 x 55 cm



5352 ... 009
ca. 36 x 80 cm

IVY

PVC



4122 ... 071*
ca. 54 x 54 cm



4122 ... 072*
ca. 39 x 69 cm

*In gerollter Aufmachung
*Rolled packaging
*Emballages roulés

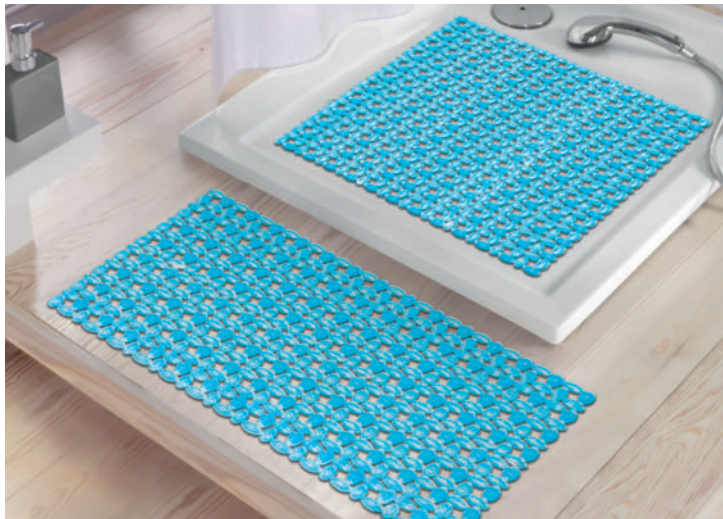

100
Weiß



116
Clear



766
Türkis

JAVA-PLUS

TPE



0241 ... 008
ca. 32 x 22 cm



0241 ... 002
ca. 55 x 55 cm



0241 ... 009
ca. 36 x 92 cm



100
Weiß

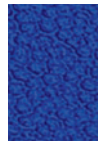

713
Royalblau

PVC FREI

- **Hohe Rutschfestigkeit**
High level of slip resistance
Qualité antidérapante élevée
- **Extreme Haltbarkeit**
Extremely durable
Durabilité extrême
- **Höchster Komfort**
Maximum comfort
Confort très élevé

JOY

PVC



4301 ... 008
ca. 32 x 22 cm



4301 ... 002
ca. 55 x 55 cm



4301 ... 005
ca. 36 x 72 cm

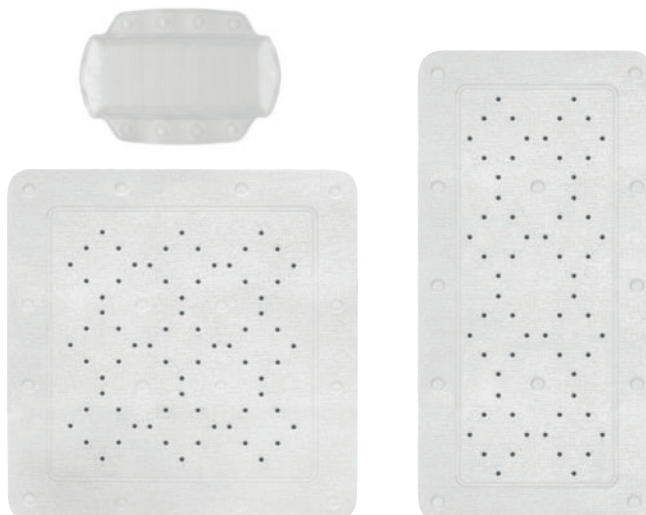

100
Weiß

MOBY

Kautschuk



PVC FREI



720
Blau

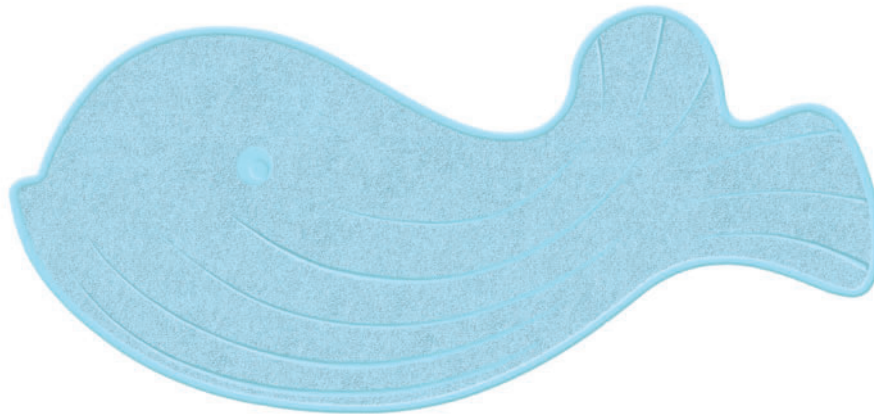

MOBY ist ein umweltfreundliches Naturprodukt

MOBY is an environmentally friendly natural product.
MOBY est un respectueux de l'environnement produit naturel



4130 ... 036
ca. 35 x 75 cm

RUBY

Kautschuk



PVC FREI



RUBY ist ein umweltfreundliches Naturprodukt

RUBY is an environmentally friendly natural product.
RUBY est un respectueux de l'environnement produit naturel



146
Silbergrau



649
Opal



742
Wasserblau

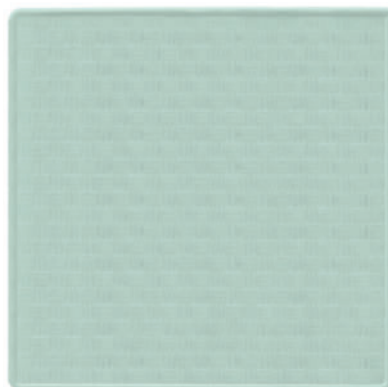

4129 ... 118
ca. 53 x 53 cm



4129 ... 036
ca. 35 x 75 cm

*In gerollter Aufmachung
*Rolled packaging
*Emballages roulés

SAMOA-PLUS

TPE



PVC FREI



100
Weiß



0204 ... 002
ca. 55 x 55 cm



0204 ... 001
ca. 36 x 92 cm

SERENE

PVC FREI

Kautschuk



Komfortables Sitzen oder Liegen
durch speziell geformte Luftpolster

Comfortable to sit or lie on thanks to specially
shaped air cushions.
Position d'assise ou de couchage confortable
grâce aux coussins d'air de forme spéciale.

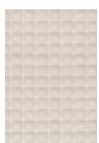
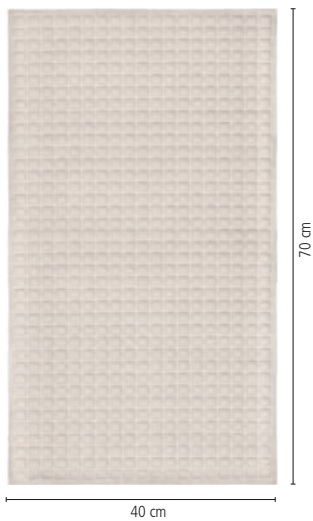
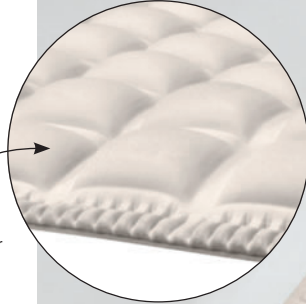

202
Natur



4143 ... 421
ca. 40 x 70 cm



SERENE ist ein umwelt-
freundliches Naturprodukt

SERENE is a environmentally
friendly natural product.
SERENE est un respectueux
de l'environnement produit naturel



Die Soft Touch Oberfläche der Wanneneinlage
sorgt für ein angenehmes Hautgefühl

The soft touch surface of the bath insert provides a pleasant
skin feeling.
La surface douce au toucher de l'insert du bain procure une
sensation agréable sur la peau.

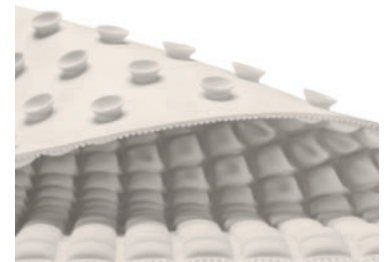

Rückseite mit vielen Saugnäpfen für einen
sicheren Halt in der Badewanne

Back with many suction cups for a secure hold in the bathtub.
Dos avec de nombreuses ventouses pour une bonne tenue
dans la baignoire.



116
Clear



124
Silber

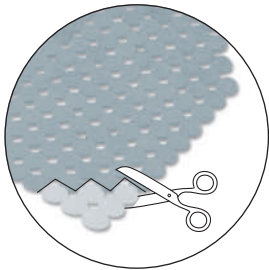

Kann individuell zugeschnitten werden

Can be individually tailor-made
Peut être découpé individuellement

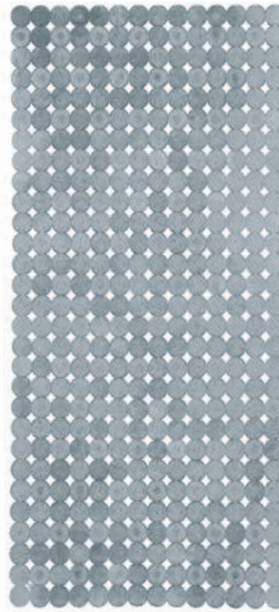
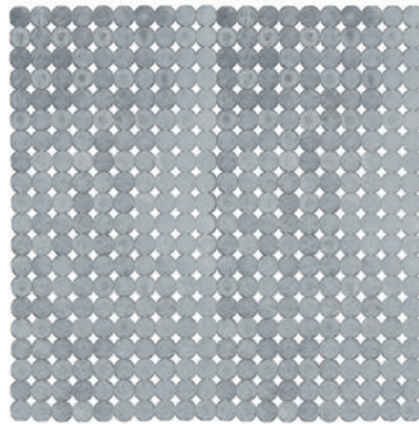

PVC



4384 ... 002
ca. 55 x 55 cm



4384 ... 009
ca. 36 x 80 cm

WELLNESS

PVC



Polster 1
verlängertes
Nackenpolster

Cushion 1
featuring an extended
neck pad

Coussin 1
pour prolonger le
coussin de la nuque

Polster 2
als Sitzstütze

Cushion 2
serves as back support

Coussin 2
comme support de siège

Polster 3
zum Liegen

Cushion 3
is for lying down

Coussin 3
pour pouvoir s'allonger



100
Weiß



4120 ... 013
ca. 36 x 145 cm

ANCHOR

PVC



5366* ... 008
ca. 32 x 22 cm



4107 ... 002
ca. 55 x 55 cm



4107 ... 001
ca. 36 x 92 cm



789
Dunkelblau
*100 Weiß

Das passt dazu:
That fits: / Ça correspond:



ANCHOR
Textiler Duschvorhang
mit Ankermotiv

Textile shower curtain with
anchor motif
Rideau de douche en textile
avec motif d'ancrage
> Seite 200 / page 200

BEACH

PVC



4300 ... 008
ca. 32 x 22 cm



4300 ... 002
ca. 55 x 55 cm



4300 ... 005
ca. 36 x 72 cm



4300 ... 001
ca. 36 x 92 cm

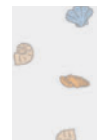
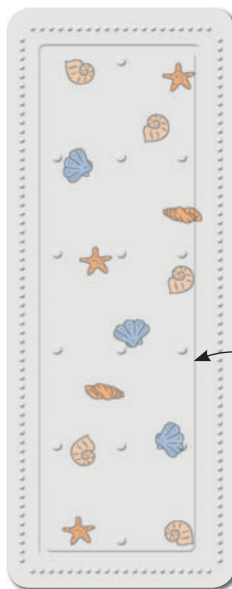

148
Multicolor

Auch in
36 x 72 cm
erhältlich

Also available in size 36 x 72 cm
Aussi disponible en taille 36 x 72 cm

BUBBLE

PVC



5313 ... 008
ca. 32 x 22 cm



5313 ... 002
ca. 55 x 55 cm



5313 ... 001
ca. 36 x 92 cm



769
Marineblau

Das passt dazu:
That fits: / Ça correspond:

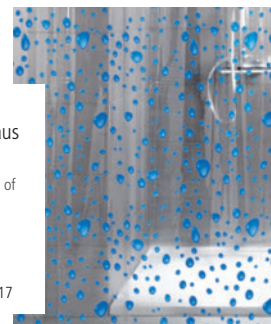

BUBBLE
Duschvorhang aus
100% PEVA

Shower curtain made of
100% PEVA
Rideau de douche
100% PEVA
ca. 180 x 200 cm
> Seite 217 / page 217

BUTTERFLIES



148
Multicolor
*100 Weiß



PVC



5366* ... 008
ca. 32 x 22 cm



4101 ... 002
ca. 55 x 55 cm



4101 ... 001
ca. 36 x 92 cm

CHARLIE



625
Maigrün
*100 Weiß

Das passt dazu:
That fits: / Ça correspond:



CHARLIE
Duschvorhang aus
100% PEVA
Shower curtain made of
100% PEVA
Rideau de douche
100% PEVA
ca. 180 x 200 cm
> Seite 218 / page 218

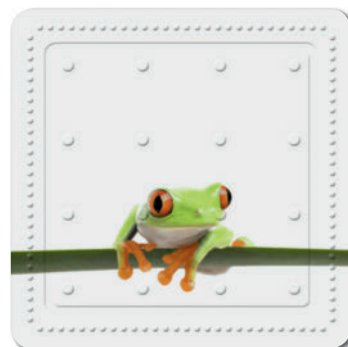

PVC



5366* ... 008
ca. 32 x 22 cm



5309 ... 002
ca. 55 x 55 cm



5309 ... 001
ca. 36 x 92 cm

EULE



271
Taupe
*100 Weiß

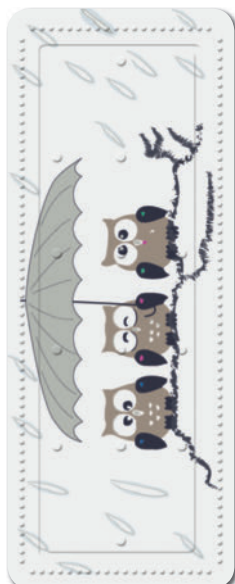

PVC



5366* ... 008
ca. 32 x 22 cm



5370 ... 002
ca. 55 x 55 cm



5370 ... 001
ca. 36 x 92 cm

KOLIBRI

PVC



4140 ... 008
ca. 32 x 22 cm



4140 ... 002
ca. 55 x 55 cm



4140 ... 001
ca. 36 x 92 cm



148
Multicolor



Das passt dazu:
That fits: / Ça correspond:



KOLIBRI
WC-Deckel mit
passendem Motiv
WC lid with fitting image
Couvercle de WC avec
image appropriée
> Seite 195 / page 195

MARBLE

PVC



4102 ... 008
ca. 32 x 22 cm



4102 ... 002
ca. 55 x 55 cm



4102 ... 001
ca. 36 x 92 cm

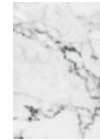
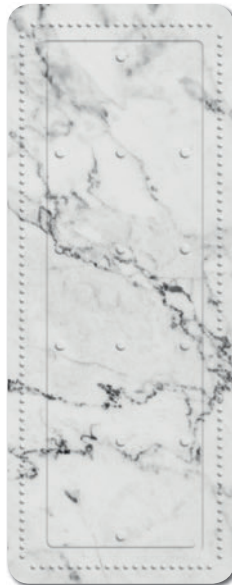
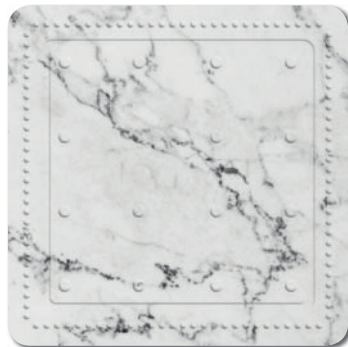

901
Anthrazit

ROSALIE

PVC



4119 ... 008
ca. 32 x 22 cm



4119 ... 002
ca. 55 x 55 cm



4119 ... 001
ca. 36 x 92 cm



148
Multicolor

ROSEMARIE



428
Bordeaux



PVC



4132 ... 008
ca. 32 x 22 cm



4132 ... 002
ca. 55 x 55 cm



4132 ... 001
ca. 36 x 92 cm

SAFARI



682
Green

Das passt dazu:
That fits: / Ça correspond:



SAFARI
WC-Deckel mit
passendem Motiv
WC lid with fitting image
Couvercle de WC avec
image appropriée
> Seite 196 / page 196



PVC



4138 ... 008
ca. 32 x 22 cm



4138 ... 002
ca. 55 x 55 cm



4138 ... 001
ca. 36 x 92 cm

STARS



146
Silbergrau



PVC



4121 ... 008
ca. 32 x 22 cm



4121 ... 002
ca. 55 x 55 cm



4121 ... 001
ca. 36 x 92 cm

STEPSTONE

PVC



4387 ... 008
ca. 32 x 22 cm



4387 ... 002
ca. 55 x 55 cm



4387 ... 001
ca. 36 x 92 cm

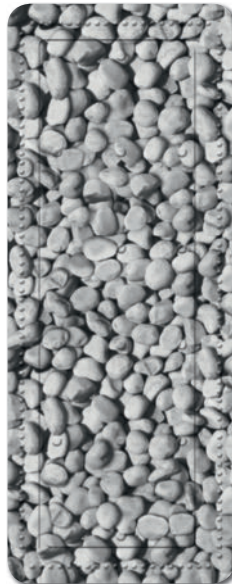
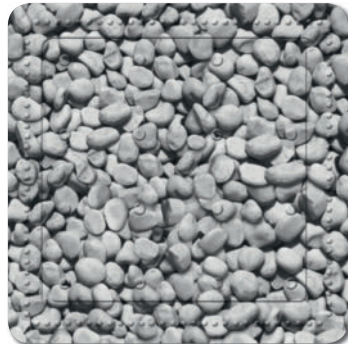

189
Grau



202
Natur

WAIKIKI

PVC



4133 ... 002
ca. 55 x 55 cm



4133 ... 001
ca. 36 x 92 cm



148
Multicolor

Das passt dazu:
That fits: / Ça correspond:

WAIKIKI
Textiler Duschvorhang
mit Strandmotiv

Textile shower curtain
with beach motif
Rideau de douche en textile
avec motif de plage

> Seite 215 / page 215

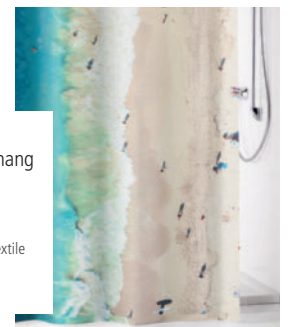

ZEN

PVC



5366* ... 008
ca. 32 x 22 cm



5363 ... 002
ca. 55 x 55 cm



5363 ... 001
ca. 36 x 92 cm

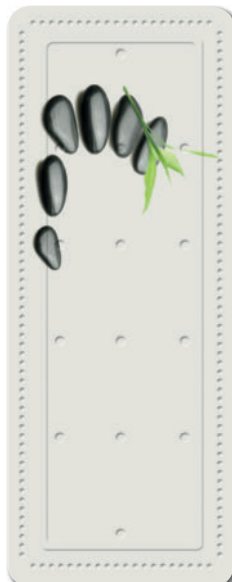

185
Schwarz Weiß
*100 Weiß

Das passt dazu:
That fits: / Ça correspond:

ZEN
WC-Deckel mit
passendem Motiv

WC seat with
matching motif
Abattant WC avec
motif assorti

> Seite 197 / page 197



PILLOW



100
Weiß



Die ideale Ergänzung zu allen Sicherheitseinlagen mit Motiv

The ideal complement to all safety inserts with motifs
L'atout idéal pour compléter tous les tapis antidérapants à motif



5366 ... 008
ca. 32 x 22 cm

ANTI-RUTSCH STICKER

Anti-Rutsch Sticker für Dusche und Badewanne / Anti-slip stickers for the shower and bath / Pastilles antidérapantes pour douche et baignoire

PVC



- sicherer Halt
safe grip
stabilité assurée
- transparent
transparent
transparent
- selbstklebend
self adhesive
auto-adhésif
- leicht ablösbar
easily removable
facilement détachable

TAPE

Anti-Rutsch-Band,
individuell zuschneidbar

Anti-slip tape, customisable
Bande antidérapante, cuttable

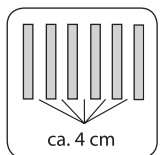

116 Clear

4144 ... 060

Rolle, individuell zuschneidbar
Roll, individually cut to size
Rôle, coupé individuellement
5 m x 2 cm



STRIPES Set 6-teilig

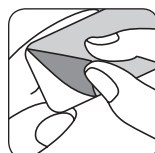
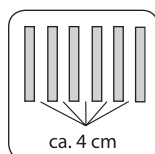

116
Clear

4111 ... 948

Set 6-teilig / 6 parts / 6 parties
Stück / piece / pièce: ca. 25 x 1,8 cm

DAISIES Set 18-teilig

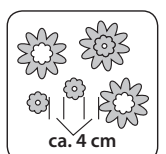

116
Clear

4128 ... 976

Set 18-teilig / 18 parts / 18 parties
9 x Ø 10,5 cm + 9 x Ø 4,5 cm



MINIS

**Dekomotive mit Saugnäpfen auf der Rückseite.
Zur Verschönerung von Dusche, Wanne und
Fliesen im Bad.**

Decorative motifs with suction cups on the back. For the decoration of shower, bathtub and tiles in the bathroom.

Motifs décoratifs avec ventouses à l'arrière. Pour embellir votre douche, votre baignoire et votre carrelage de salle de bains.



FLIP

PVC



791
Himmelblau



4379 ... 969

Set 4-teilig / 4 parts / 4 parties

JELLY

PVC



625
Maigrün



4380... 969

Set 4-teilig / 4 parts / 4 parties

SHARKY

PVC

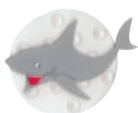

901
Anthrazit

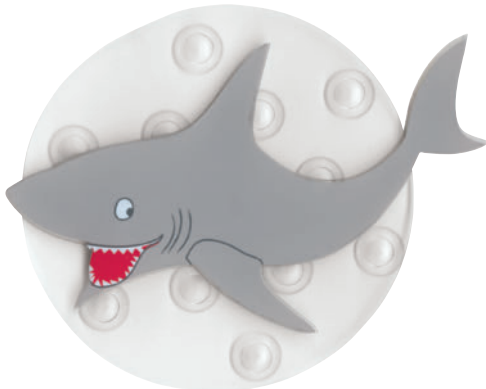

5364 ... 969

Set 4-teilig / 4 parts / 4 parties

STERN

PVC



568
Sunshine



4382... 969

Set 4-teilig / 4 parts / 4 parties

FUSS

PVC



100
Weiß



711
Moon



4209 ... 948
Set 6-teilig / 6 parts / 6 parties

GUPPI

PVC

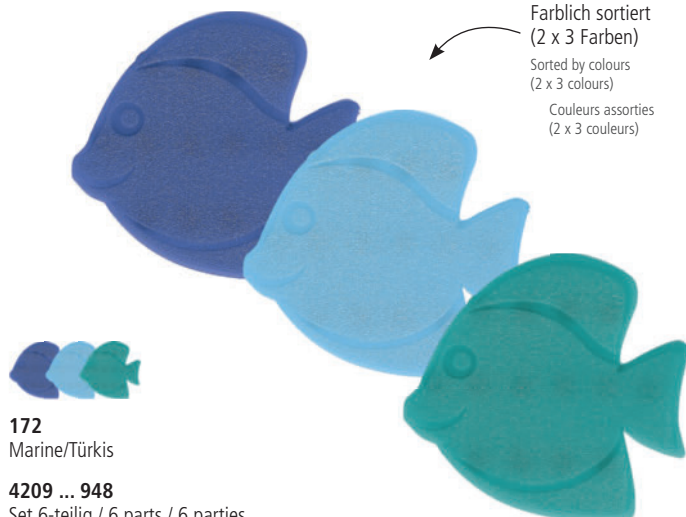

Farblich sortiert
(2 x 3 Farben)
Sorted by colours
(2 x 3 colours)
Couleurs assorties
(2 x 3 couleurs)

172
Marine/Türkis

4209 ... 948
Set 6-teilig / 6 parts / 6 parties



PVC

720
Blau

4131 ... 948
Set 6-teilig / 6 parts / 6 parties

MINI MOBY

Farblich sortiert
(3 x 2 Farben)
Sorted by colours
(3 x 2 colours)
Couleurs assorties
(3 x 2 couleurs)



MUSCHEL

PVC



114
Schneeweiß



256
Caramel



4209 ... 948
Set 6-teilig / 6 parts / 6 parties

PVC



100
Weiß



139
Rauchgrau



4123 ... 948
Set 6-teilig / 6 parts / 6 parties



EINSTIEGSPREISLAGEN

ENTRY PRICE LEVELS

CATÉGORIES DE PRIX DE DÉPART



Die kostengünstige Ergänzung zu unserer Badkollektion

- kleines, aber feines Programm für jeden Badbereich
- Markenqualität
- attraktive, moderne Designs
- ideal für Zweitplatzierung

The cost-effective complement to our bathroom collection

- small but nice produktrange for every bathroom
- brand quality
- attractive, modern designs
- ideal for second place

Le complément économique de notre collection de salle de bain

- petit mais joli produit pour chaque salle de bain
- la qualité de la marque
- dessins attrayants et modernes
- idéal pour la deuxième place

<p>BADTEPPICH FINN Seite / page 255</p>  	<p>KOSMETIKEIMER MATCH Seite / page 257</p>  	<p>KOSMETIKEIMER ONE Seite / page 257</p>  	<p>KOSMETIKEIMER SWIFT Seite / page 257</p>  	
<p>BADTEPPICH SANDY Seite / page 255</p>  	<p>DV-SORTIMENT MOTION Seite / page 258</p>  		<p>DV-SORTIMENT PROMO Seite / page 258</p>  	
<p>BADTEPPICH TAMMY Seite / page 255</p>  	<p>DUSCH-SET Seite 258</p>  	<p>DUSCHROLLO Seite / page 259</p>  	<p>SICHERHEITSEINLAGE CALYPSO Seite / page 259</p>  	
<p>ACCESSOIRES MATCH Seite / page 256</p>  	<p>ACCESSOIRES PLENTY Seite / page 256</p>  		<p>SICHERHEITSEINLAGE FOOT Seite / page 259</p>  	

FINN



100
Weiß



146
Silbergrau



202
Natur



905
Schiefer



100% Cotton



Für Fußbodenheizung
geeignet

Florhöhe (mm)
Pile height
Hauteur mèches

10

Praktische Aufmachung in gerollter Form

Practical presentation in rolled form
Présentation pratique sous forme roulée



5534 ... 433
ca. 60 x 50 cm

5534 ... 207
ca. 80 x 50 cm



SANDY



201
Beige



443
Magnolie



742
Wasserblau



913
Nebel



100% Polyester



Für Fußbodenheizung
geeignet

Florhöhe (mm)
Pile height
Hauteur mèches

6 12

Praktische Aufmachung in gerollter Form

Practical presentation in rolled form
Présentation pratique sous forme roulée

5537 ... 433
ca. 60 x 50 cm

5537 ... 207
ca. 80 x 50 cm

TAMMY



100
Weiß



453
Rubin



600
Grün



766
Türkis



100% Polyester



Für Fußbodenheizung
geeignet

Florhöhe (mm)
Pile height
Hauteur mèches

12

Praktische Aufmachung in gerollter Form

Practical presentation in rolled form
Présentation pratique sous forme roulée

5535 ... 433
ca. 60 x 50 cm

5535 ... 207
ca. 80 x 50 cm

MATCH

AS Kunststoff / AS plastic / AS plastique



100
Weiß



201
Beige



977
Platin

Mit Chrom Elementen
With chrome elements
Avec éléments chromés



10,6 cm

6,6 cm

***8482 ... 852**
Zahnputzbecher
Tumbler
Gobelet de brosse à dents



16,0 cm

6,6 cm

***8482 ... 854**
Seifenspender
Soap dispenser
Dispenseur de savon



37,4 cm

9,0 cm

8482 ... 856
WC-Bürstengarnitur
Toilet brush holder
Porte-brosse de toilette

*VE = 2 Stück / 2 pieces / 2 unités

PLENTY

Polypropylen



100
Weiß



901
Anthrazit



10,3 cm

7,2 cm

***5850 ... 852**
Zahnputzbecher
Tumbler
Gobelet de brosse à dents



16,5 cm

7,2 cm

***5850 ... 854**
Seifenspender
Soap dispenser
Dispenseur de savon



37,5 cm

9,3 cm

***5850 ... 856**
WC-Bürstengarnitur
Toilet brush holder
Porte-brosse de toilette



*VE = 6 Stück / 6 pieces / 6 unités

NEW

ONE

Metall

Treteimer
Pedal bin
Poubelle à pédale



Herausnehmbarer
Inneneimer
Removable inner
container
Seau intérieur
amovible



Tragegriff auf
der Rückseite
Handle on the back
Poignée sur le arrière



3 l Inhalt 3 Liter
Content 3 litres
Contenu 3 litres

8058 ... 858
ca. 16,8 x 25 cm



100
Weiß



202
Natur



431
Rouge



649
Opal



926
Schwarz



977
Platin

MATCH

AS Kunststoff / AS plastic / AS plastique

**Schwing-
deckeleimer**
Swing bin
Poubelle à couvercle
basculant



100
Weiß



201
Beige



977
Platin

5 l Inhalt 5 Liter
Content 5 litres
Contenu 5 litres

8484 ... 858
ca. 18 x 24,3 cm

VE = 2 Stück / 2 pieces / 2 unités

SWIFT

Polypropylen

Kosmetikeimer
Cosmetic bucket
Seau cosmétique



100
Weiß



901
Anthrazit

5 l Inhalt 5 Liter
Content 5 litres
Contenu 5 litres

8485 ... 858
ca. 19,4 x 27,5 cm

VE = 2 Stück / 2 pieces / 2 unités

MOTION

TEXTIL 100% Polyester

10 Duschvorhänge, sortiert, mit je 12 weißen DV-Ringen. Unterschiedliche Designs

10 Shower curtains, sorted, each with 12 white shower curtain rings. Different designs

10 Rideaux de douche, assortis, munis chacun de 12 anneaux de rideau de douche blancs. Différents modèles



4947 000 305
ca. 180 x 200 cm



Beispielabbildungen
Examples / Exemples



Wasserabweisend
With water-repellent finish
Traitement hydrofuge

PROMO

ÖKOPLAST 100% PEVA **PVC-frei**

10 Duschvorhänge, sortiert, mit je 12 weißen DV-Ringen. Unterschiedliche Designs

10 Shower curtains, sorted, each with 12 white shower curtain rings. Different designs

10 Rideaux de douche, assortis, munis chacun de 12 anneaux de rideau de douche blancs. Différents modèles

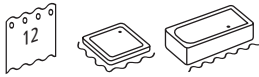

4837 000 305
ca. 180 x 200 cm



Beispielabbildungen
Examples / Exemples

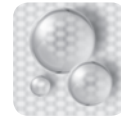

Wasserdicht
Waterproof
Étanche à l'eau



Ökoplast-Duschvorhänge sind PVC-frei. Sie werden ohne Zusätze von Chloriden und Cadmium gefertigt und sind recyclingfähig.

Ökoplast shower curtains are PVC-free. They are manufactured without any chloride or cadmium additives and are recyclable.

Les rideaux de douche Ökoplast ne contiennent pas de PVC. Ils sont fabriqués sans addition de chlorures ni de cadmium et sont recyclables.

DUSCH-SET

100% VINYL

Komplett-Paket in 2 Größen

Complete package in 2 sizes
Forfait complet en 2 tailles

3313 Set 3-tlg. (920)

- 1 > DV-Stange 75-125 cm
- 2 > Duschvorhang 120 x 200 cm
- 3 > 8 DV-Ringe

3313 100 920
Dusch-Set klein, weiß

3313 Set 3-tlg. (921)

- 1 > DV-Stange 125-220 cm
- 2 > Duschvorhang 180 x 200 cm
- 3 > 12 DV-Ringe

3313 100 921
Dusch-Set groß, weiß



1 DV-Stange
Universal rod
Barre universelle

2 DV-Ringe
Shower curtain rings
Anneaux pour rideau de douche

3 Duschvorhang
Shower curtain
Rideau de douche



Wasserdicht
Waterproof
Étanche à l'eau

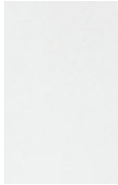

100
Weiß

Wasserdicht
Waterproof
Étanche à l'eau



DUSCHROLLO

100% VINYL

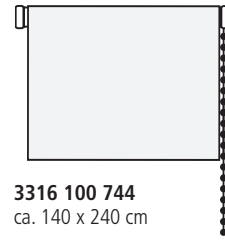

3316 100 744
ca. 140 x 240 cm



Seitliche Kürzung möglich
Sides can be shorted
Raccourcissement latéral possible



100
Weiß



201
Beige



425
Tomate



669
Kiwi



726
Lagoon



732
Kobaltblau



733
Krokusblau



977
Platin



4325 ... 002
ca. 55 x 55 cm



4325 ... 917
Set 2-tlg.
32 x 22 cm
36 x 72 cm



CALYPSO

PVC



189
Grau



226
Sandbeige



453
Rubin



488
Orange



615
Kiwigrün



720
Blau



905
Schiefer



FOOT

Kautschuk / Rubber / Caoutchouc

PVC-frei



4388 ... 002
ca. 55 x 55 cm



4388 ... 005
ca. 36 x 72 cm



POS EXCELLENCE

Ihre Verkaufsfläche exakt und individuell auf Ihre Wünsche zugeschnitten – das bieten Ihnen die flexiblen Shopsysteme von KLEINE WOLKE.

Für Bestückungen auf der Freifläche und in der Rückwand haben wir die richtigen Warenträger und schaffen mit der attraktiven Umsetzung von aktuellen Farb- und Themenwelten ein neues, emotionales Einkaufserlebnis am POS.

Selbst auf den kleinsten Flächen können mit den KLEINE WOLKE Shopsystemen unterschiedlichste Warengruppen ansprechend miteinander kombiniert werden.

Gerne gestalten wir auch Ihre Flächenplanung – sprechen Sie uns an.

POS EXCELLENCE

Your retail space, tailored exactly to your wishes – that is what the flexible shop system by KLEINE WOLKE offers you. We have the right product displays for the placement of goods on the shop floor or against the back wall, and we use the attractive implementation of current colour themes to create a new, emotional shopping experience at the POS.

Even in the smallest area, the KLEINE WOLKE shop system can combine very different product groups attractively with each other.

We would love to design your space too – talk to us about it!

POS EXCELLENCE

Votre espace de vente personnalisé exactement selon vos désirs – voilà ce que vous offre les systèmes d'agencement modulables KLEINE WOLKE. Pour équiper des espaces libres ou des parois murales, nous disposons des supports appropriés et créons ainsi une ambiance particulière dans votre point de vente en utilisant des thèmes et des couleurs actuels.

Même dans les plus petits espaces, différentes catégories de produits peuvent être facilement combinées grâce aux systèmes d'agencement KLEINE WOLKE. Nous pouvons également planifier l'agencement de votre boutique – contactez-nous!

DESIGNWELT Framework



VARIO mit Kopfregal und Musterpräsentation Framework

VARIO with end cap display and
sample presentation Framework
VARIO avec tête de gondole et présentation
de l'échantillon de Framework



Abmessungen (B x H x T)
Dimensions

268 x 148 x 80 cm

(mit Musterpräsentation = Höhe 173 cm)

(with sample presentation = height 173 cm)

(avec présentation de l'échantillon = hauteur 173 cm)

Warenträgerkonzept Shop VARIO

Maximale Flexibilität und Funktionalität – das bietet Shop VARIO designed by KLEINE WOLKE. Das modulare System in den Farbtönen Anthrazit und Weiß in Kombination mit edlem Eichenholz-Dekor kann individuell mit unterschiedlichsten Bauteilen und Emotionals erweitert und ergänzt werden und bietet so eine attraktive, auf Kundenbedürfnisse zugeschnittene Präsentation unterschiedlichster Warengruppen für ein emotionales Einkaufserlebnis am POS. Mit der Flächenplanung in ansprechenden Farb- und Themenwelten wird ebenfalls das Impulsgeschäft durch Verbundkäufe erzielt für Zusatzumsatz und Ertragssteigerung.

Display Concept Shop VARIO

Maximum flexibility and functionality – that is what Shop VARIO, designed by KLEINE WOLKE, has to offer. The modular system, in the colours anthracite and white, can be expanded and added to with the use of different components and motifs, and therefore offers an attractive way to present even the most varying product groups which is geared towards customer needs, for an emotive shopping experience at the POS. With an area plan in an appropriate colour scheme and theme, displaying products together encourages impulse purchases of interrelated products: great for additional turnover and an increase in earnings.

Display Concept Shop VARIO

Flexibilité et fonctionnalité maximum – c'est le concept du Shop VARIO designed by KLEINE WOLKE. Le système modulaire en couleurs anthracite et blanc peut être élargi et complété individuellement avec différents éléments et objets «émotion», et offre une présentation de différentes catégories de produits attractive et adaptée aux besoins du client pour une expérience d'achat agréable en point de vente. Grâce aux différents thèmes et couleurs proposés, l'agencement de votre boutique fera naître chez vos clients des envies d'achats spontanés et groupés, ce qui permettra d'augmenter vos recettes et d'améliorer votre rendement.

SHOPWELT RÜCKWAND

POS RÜCKWAND

Rear wall
Panneau arrière

DESIGNWELT *Framework*



DESIGNWELT *Magical Moments*



POS RÜCKWAND

Rear wall
Panneau arrière



DESIGNWELT
J'adore



DESIGNWELT
Green Infusion



3er VARIO mit Badteppich-Stange

VARIO with bath rug bar
VARIO avec bar à tapis de bain

DESIGNWELT

J'adore



Abmessungen (B x H x T)

Dimensions

268 x 148 x 80 cm



3er VARIO

mit Badteppich-Schrägabhänger

VARIO with bath rug sloping hanger
VARIO avec cintre diagonal pour tapis de bain

DESIGNWELT

Magical Moments



Abmessungen (B x H x T)

Dimensions

235 x 148 x 80 cm

3er VARIO mit Badteppich-Schrägabhänger

VARIO with bath rug sloping hanger
VARIO avec cintre diagonal pour tapis de bain

DESIGNWELT *Green Infusion*



Abmessungen (B x H x T)
Dimensions
235 x 148 x 80 cm



BADTEPPICHPRÄSENTER

Bath mat display unit
Présentoir pour tapis de bain

Abmessungen (B x H x T)
Dimensions
130 x 144 x 50 cm

Freiflächen-Präsentier Spiegel

Open-space presenter mirror / Présentoir espace libre miroir



Rückwand Spiegel

Rear wall mirror / Panneau arrière miroir



Die optimale Produktpräsentation - flexibel und individuell

Die Warengruppe Spiegel mit unterschiedlichen Anbringungs- und Stellmöglichkeiten lässt sich attraktiv und ansprechend mit Funktionsmodellen in einer flexiblen Freiflächen-Platzierung darstellen, als auch in einer optimalen Rückwand-Abwicklung.

Optimum product presentation - flexible and unique

The mirror product group, with its various options for attachments and adjustments, lends itself to being displayed attractively and appealingly with functional models in a flexible open space, or alternatively in a fantastic rear wall arrangement.

La présentation optimale du produit - flexible et individuelle

Le groupe de produits Spiegel avec ses différentes possibilités de mise en place et d'arrangement, est présenté de manière attractive et plaisante grâce au placement des modèles d'exposition sur des espaces libres flexibles ou comme présentation murale optimale.

Die optimale Produktpräsentation - hochwertig und individuell

Accessoires-Tisch

Alternative, warengruppen-übergreifende Platzierungsmöglichkeiten bietet die maßgeschneiderte und hochwertige Tisch-Präsentation – nicht nur für Accessoires.

The optimal product presentation - high quality and individual

Accessories table

The tailor-made and high value table presentation offers alternative placement opportunities spanning different product groups.

La présentation optimale du produit - haute qualité et individuel

Table pour accessoires

Les présentations sur table personnalisées et de qualité supérieure offrent un choix alternatif aux présentations classiques de produits.

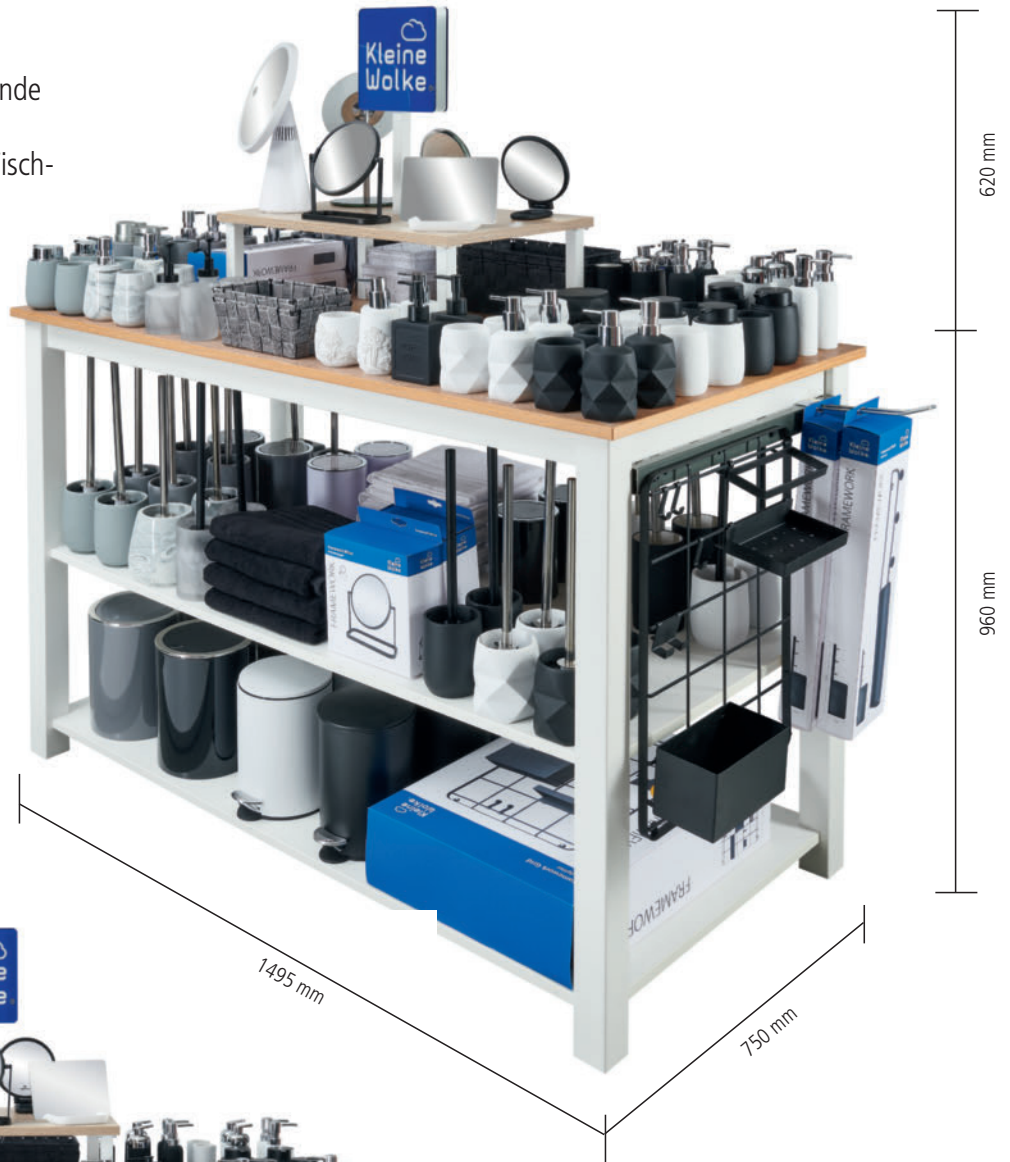

*Die optimale Produktpräsentation –
zum Informieren und Testen*

Freiflächen-Präsentier Duschrollo
Open-space presenter shower blind
Présentoir espace libre store de douche



Rückwand Duschrollo
Rear wall shower blind
Panneau arrière store de douche



Duschrollo-Präsentation

Egal, ob für Freifläche oder Rückwand – auch für diese Warengruppe hat KLEINE WOLKE eine perfekt abgestimmte Warenpräsentation mit Anwendungsbeispiel entwickelt.

The optimal product presentation – for information and testing

Shower Blind Presentation

KLEINE WOLKE has developed the perfect way to present this product group by means of a usage example – be this on the shop floor or the back wall.

La présentation optimale du produit – pour information et test

Présentation store de douche

Qu'ils soient destinés à un espace libre ou à une paroi murale, KLEINE WOLKE a également développé une présentation harmonieuse avec exemples d'application pour cette catégorie de produits.

Die dreifache Produktpräsentation – passend für jeden Platz

Mit bis zu 3 unterschiedlichen Präsentationsformen stellt KLEINE WOLKE die Warengruppe der WC-Sitze gekonnt in Szene. Für ein harmonisches POS-Erscheinungsbild, individuell auf Ihre Ansprüche ausgelegt, gibt es diese Warenträger zur Wahl in den Dekoren Anthrazit, Alu, Weiß, Ahorn oder Buche.

Toilet Seat Presentation

With up to 4 different presentation forms, KLEINE WOLKE knows exactly how to present toilet seats as a product group. For a harmonic POS appearance that is designed individually for your needs, these product displays are available in anthracite, aluminium, white, maple or beech.

Présentation abattants WC

KLEINE WOLKE met en scène la catégorie des abattants WC à travers 4 choix de présentation différents. Pour obtenir un point de vente individuel et harmonieux correspondant à vos attentes, ces supports sont conçus au choix avec des décors en anthracite, aluminium, blanc, érable ou hêtre.

Querpräsentier

Cross presenter / Présentateur croix

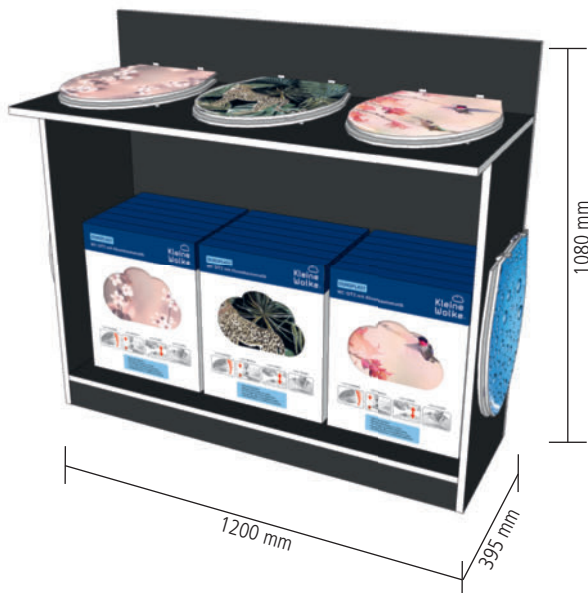

Säule

Pillar / Colonne



Paletten-Präsentier

Pallet presenter / présentateur de palettes

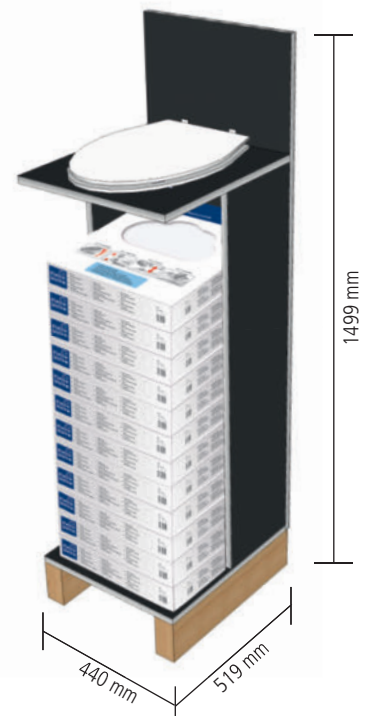

Beispielbestückung Querpräsentier

Sample placement
Exemple d'équipement

Modell Modell Modèle	Farbe Colour Couloeur	Anzahl Number Nombre
Marble	Anthrazit	4
Blossom	Nelke	4
Safari	Green	4
Kolibri	Multicolor	4
Bubble	Marineblau	4
Ersatz Montageset	Chromfarbig	3
Ersatz Deckelpuffer	Weiß	3

Beispielbestückung Säule

Sample placement
Exemple d'équipement













Modell Modell Modèle	Farbe Colour Couloeur	Anzahl Number Nombre
Charlie	Grün	3
Zen	Multicolor	3
Kolibri	Multicolor	3
Safari	Green	3
Blossom	Nelke	3
Butterflies	Multicolor	3
Marble	Anthrazit	2
Rosalie	Multicolor	2
Sandstrand	Beige	3
Ersatz Montageset	Chromfarbig	3
Ersatz Deckelpuffer	Weiß	3

Beispielbestückung Paletten-Präsentier

Sample placement
Exemple d'équipement

Modell Modell Modèle	Farbe Colour Couloeur	Anzahl Number Nombre
Uni	Dunkelblau	12
Ersatz Montageset	Chromfarbig	3
Ersatz Deckelpuffer	Weiß	3

PFLEGESYMBOLLE Care symbols / Symboles de soins

 Schonwaschgang Delicate wash cycle Programme pour textiles fragiles	 Nicht bleichen Do not bleach Ne pas blanchir	 Warm bügeln Iron warm Repasser chaud	 Keine chemische Reinigung möglich No dry cleaning possible Pas de nettoyage à sec possible
 Schonwaschgang Delicate wash cycle Programme pour textiles fragiles	 Trocknen mit reduzierter thermischer Beanspruchung Drying with reduced thermal stress Sécher avec charge thermique réduite	 Mäßig heiss bügeln Iron moderately hot Repasser à température moyenne	
 Handwäsche Hand wash Lavage à la main	 Nicht im Wäschetrockner trocknen Do not dry in a dryer Ne pas sécher dans le sèche-linge	 Nicht bügeln Do not iron Ne pas repasser	
 Fußbodenheizungsgeeignet Suitable for underfloor heating Approprié au chauffage de sol			
 Spülmaschinengeeignet Dishwasher-proof Lavable au lave-vaisselle		 Nicht spülmaschinengeeignet Not dishwasher-safe Ne va pas au lave-vaisselle	

ZERTIFIKAT Certificate / Certificat



Geprüft und zertifiziert nach Öko-Tex Standard 100.
Frei von gesundheitlich bedenklichen Schadstoffmengen.

Quality mark for tested and certified textiles, free from quantities of toxic substances that are questionable with regard to health.

Label pour des textiles contrôlés et certifiés, exempts de quantités d'agents toxiques dangereux pour la santé.

NACHHALTIGE NATURPRODUKTE

Sustainable natural products / Produits naturels durables



Kollektion aus nachwachsenden Rohstoffen

Collection from renewable raw materials
Collecte à partir de matières premières renouvelables

In der heutigen Zeit sind Nachhaltigkeit und Umweltbewusstsein zentrales Thema in der Gesellschaft. Das **ECO-LIVING-Sortiment** von Kleine Wolke erfüllt alle Anforderungen einer umweltbewussten Kollektion aus nachwachsenden Rohstoffen. Gesundheitsverträgliche Rohstoffe und biologisch abbaubare Fasern werden zu nachhaltigen Produkten gefertigt.

The Kleine Wolke label for environmentally products in the bathroom. The ECO LIVING range from Kleine Wolke meets all the requirements of an eco-conscious collection made from renewable raw materials. Healthy raw materials and biodegradable fibres are made into sustainable products.

Le Kleine Wolke label pour des produits de salle de bains respectueux de l'environnement. Le ECO LIVING de Kleine Wolke remplit toutes les conditions d'une collection respectueuse de l'environnement élaborée à partir de ressources renouvelables. Des matières premières sans danger pour la santé et des fibres biodégradables, tous ces éléments permettent la fabrication de produits durables.



Kollektion aus recycelten Materialien

Collection from recycled materials
Collecte de matériaux recyclés

Die Badteppich Kollektion **ECO CARE** besteht zu 100% aus recycelter Baumwolle oder PET-Flaschen. Durch den geringen Energieverbrauch beim Abbau, der Verarbeitung und dem Transport lassen sich erheblich CO₂-Emissionen einsparen und Kleine Wolke trägt damit zum Klimaschutz bei. Durch das nachhaltige Recycling lassen sich Ressourcen nutzen, Energie einzusparen und die Umwelt zu schonen.

The Eco Care bath mat collection is made of 100% recycled cotton or PET bottles. Due to the low energy consumption during dismantling, processing and transport, considerable CO₂ emissions can be saved and Kleine Wolke thus contributes to climate protection. Through sustainable recycling, resources can be used, energy can be saved and the environment can be protected.

La collection de tapis de bain Eco Care est composée de bouteilles en coton ou en PET recyclées à 100%. Grâce à la faible consommation d'énergie lors du démantèlement, du traitement et du transport, il est possible d'économiser des émissions de CO₂ considérables et Kleine Wolke contribue ainsi à la protection du climat. Le recyclage durable permet d'utiliser les ressources, d'économiser l'énergie et de protéger l'environnement.



Kleine Wolke
Textilgesellschaft mbH & Co. KG
Postfach 75 02 65
28722 Bremen / Germany
E-Mail: export@kleinewolke.com

SALES SERVICE

Haben Sie Fragen?
Wir helfen Ihnen gerne.

For further information do not
hesitate to contact us.

Avez-vous des questions?
N'hésitez pas de nous contacter.

Head of Export

Betrand Pichon
Tel. +49 421 6261-120
Fax +49 421 6261-230

Customer Service Export

Sabine Krannich
Tel. +49 421 6261-235
Fax +49 421 6261-230

Marc Lutz
Tel. +49 421 6261-233
Fax +49 421 6261-230

Schweiz

Kleine Wolke AG
Feldstraße 2
CH-5506 Mägenwil
Tel. +41 56 648 41 21
Fax +41 56 648 41 29
E-Mail: info@kleinewolke.ch
www.kleinewolke.ch

Österreich

Leifheit AG
Niederlassung Österreich
IZ NÖ-Süd, Strasse 16, Objekt 69/5/II
2355 Wiener Neudorf/Austria
Tel. +43 2236 64923
Fax +43 2236 64924
E-Mail: info.austria@leifheit.com

REGISTER

CREATIVO DESIGN

Angelo	24
Cassetta	25
Centro	26
Collina	27
Copertina Deckel	23
Corso	28
Emozione	29
Grandezza	22-23
Harmonia	30
Interno	31
Meandro	32
Melodia	33
Mitilo	34
Relax	18-19
Valletta	35

BADTEPPICHE

Anti-Rutsch	89
Beach	40
Bloom	41
Bola	42
Caro	43
Carla	44
Cassy	45
Celine	46
Cony	47
Cory	48
Cosima	49
Cubetto	50
Dakota	51
Fiesta	52
Fiona	53
Hailey	54
Helena	55
Inspire	56
Isa	57
Julie	58
Lexy	59
Lounge	60
Magic	61
Maine	62
Malin	63
Mandala	64
Meadow	65
Miami	66
Mix	67
Monrovia	68
Nelli	69
Oslo	70
Relax	38-39
Riva	71
Rumba	72
Rumble	73
Seaworld	74
Siesta	75
Sigma	76
Soft Deckel	89
Splash	77
Stella	78
Suri	79
Tender	80
Tira	81
Tivoli	82
Trend	83
Twin	84
Vanessa	85
Wave	86
Willow	87
Wilna	88

FROTTIER

Arizona	92
Botany Badteppich	93
Botany Frottier	113
Bridge Vorleger	112
Caracas	94
Cecil	95
Chrissy	96
Como	97
Coral	98
Dots	99
Everglades	100
Havanna	101
Kansas	102
Leaf Badteppich	103
Leaf Frottier	114
Life	104
Lodge Vorleger	111

FROTTIER

Merida	105
Phoenix	106
Plaza Vorleger	113
Royal Frottier	115
Santiago	107
Sara	108
Sway	109
Zagreb	110

HOLZMATTEN

Bambus Holzmatte	116
Level Holzmatte	116
Palito Holzmatte	117

ACCESSOIRES

Anchor	120
Argentic	120
Antoinette	121
Belly	123
Bento	122
Bloom	123
Bolsa	124
Bonny	125
Callisto	126
Check	126
Cooper	127
Crackle	128
Cubic	128
Dotty	129
Double	130
Dusty	130
Easy	132
Eclipse	131
Edit	132
Exotic	133
Flash	134
Fortune	134
Gloria	135
Glamour	136
Golden Crackle	137
Joker	137
Kyoto	138
Leaf	139
Loft	138
Mable	140
Mandalay	140
Marble	142
Marmor	143
Mercury	141
Mila	144
Monroe	144
Natura	145
Noblesse	146
Pino	146
Pur	147
Pur Shiny	147
Sahara	148
Soap	149
Stones	149
Stream	150
Timber	150
Touchless	151
Tricotia	151
Ersatzteile	152-154

KOSMETIKEIMER

Clap	158
Clap Mini	159
Elegance	160
Glossy	160
Golden Clap	159
Silence	161

BADORGANISATION

Brava	162
Candle	166
Chevron	162
Chico	162
Crackle Jar	166
Double Basket	163
Double Box	163
Double Laundry	163
Double Laundry Box	163
Easy Chair	165
Framework Basket	169
Framework Grid	168
Framework Shelf	169
Malvina	167
Scandic Chair	165
Timber Box	167
Tissue	166
Vita Laundry	164
Wäscheboy	164

HAKEN

Brinkle Hooks	170
Classic Hooks	170
Crazy Hooks	171
Door Hooks	172
Drop Hooks	171
Easy Hooks	172
Golden Hooks	173
Jolly Hooks	173
Marble Hooks	174
Metal Hooks	174
Mira Hooks	175
Mirror Hooks	175
Smart Hooks	176
Square Hooks	176
Stones Hook	176
Static Hooks	177
Timber Hooks	177

SPIEGEL

Base Mirror	180
Blade Mirror	180
Bright Mirror	181
Bright Mirror Shorty	181
Brilliant Mirror	182
Clever Mirror	182
Crystal Mirror	183
Easy Mirror	183
Flexy Color	184
Flexy Light	184
Framework Mirror	188
Genius Mirror	185
Lady Mirror	186
Lumi Mirror	187
Mini Mirror	188
Move Mirror	189
Multi Mirror	189
Ridge Mirror	190
Timber Mirror	190
Transparent Mirror	191
Tray Mirror	191

STATICS

192-193

WC-SITZE

Blossom	195
Bubble	195
Butterflies	195
Cosmo Cat	195
Eulen	195
Kolibri	195
Marble	196
Nova	196
Rosalie	196
Rosemarie	196
Safari	196
Sandstrand	196
Sportschuh	197
Uni	197
Waikiki	197
Zen	197
Ersatzteile	197

DUSCHVORHÄNGE

TEXTIL	
Anchor	200
Barcelona	200
Bath	200
Bathroom	201
Birdie	201
Blossom	201
Butterflies	202
Canton	202
Caravelle	203
Check	202
Classy	203
Cora	204
Eulen	204
Exotic	204
Florence	205
Floresta	205
George	205
Grid	206
Hook On	206
Jolie	207
Kito	207
Kolibri	207
Leaf	208
Linen	208
Lotus	208
Luna	209
Magic	209
Mandalay	209
Marble	210
Miami	210
Nova	210
Rica	211
Rings	211
Rosalie	211
Rosemarie	212
Safari	212
Sanna	212
Scarlett	213
Script	213
Seaside	213
Select	214
Sheep	214
Style	214
Twin	215
Waikiki	215
Yogi	215

DUSCHVORHÄNGE

PEVA	
Bambú	216
Bloom	217
Bubble	217
Cascade	217
Charlie	218
Claro	218
Clipper	218
Confetti	219
Dolphin	219
Freddy	219
Hello	220
Malediven	220
New Beach	220
Noa	221
Penguin	221
Pocket	221
Ray	222
Reiselust	222
Sealife	222
Shell	223
Soapy	223
Sonny	223
Sparkle	224
Uno	224
Viva	224
Wings	225
Zack	225
Zora	225

DUSCHVORHÄNGE

VINYL	
Cristal	226
Grafico	226
Phönix	227
Sky	227

DUSCHVORHANG

ZUBEHÖR	
Big Spider	235
Deckenhalterung	229
Duschstange Bogen	232
DV-Klammern	233
DV-Ringe	233
Duschrollo	236
Eckduschrollo	237
Endstück	231
Federstangen	230-231
Rundstange	232
Schienensystem	234
Schmales Duschrollo	237
Schrägwandhalter	231
Seilsystem	232
S-Haken	232
Spider DV-Kabine	235
Spider DV	235
Universalstange	229
Winkelstange	229

SICHERHEITSEINLAGEN

UNI	
Anti-Rutsch-Sticker	251
Arosa	240
Arosa rund	240
Casablanca	240
Formosa	241
Honey	241
Ivy	242
Java-Plus	242
Joy	242
Moby	243
Pillow	251
Ruby	243
Samoa-Plus	244
Serene	244
Sign	245
Wellness	245

SICHERHEITSEINLAGEN

MOTIV	
Anchor	246
Beach	246
Bubble	246
Butterflies	247
Charlie	247
Eule	247
Kolibri	248
Marble	248
Rosalie	248
Rosemarie	249
Safari	249
Stars	249
Stepstone	250
Waikiki	250
Zen	250

MINIS - DEKORE

252-253

EINSTIEGS-

PREISLAGEN 254-255

CLASSIC COLLECTION 2021



Kleine Wolke AG

Feldstraße 2 · CH-5506 Mägenwil
Tel. +41 56 648 41 21 · Fax +41 56 648 41 29
info@kleinewolke.ch · www.kleinewolke.ch

